

Original Article

# Organic chemical Nano sensors: synthesis, properties, and applications

## Nanossensores químicos orgânicos: síntese, propriedades e aplicações

Z. H. Mahmoud<sup>a</sup>, H. N. K. AL-Salman<sup>b</sup>, H. H. Hussein<sup>b</sup>, A. H. Adhab<sup>c</sup>, K. Al-Majdi<sup>d</sup>, T. Rasheed<sup>e</sup>, H. A. Abdulhussien<sup>f</sup>, N. Sasirekha<sup>g</sup>, A. N. Abd<sup>h</sup> and E. Kianfar<sup>i,j,\*</sup> 

<sup>a</sup>Science College University of Diyala, Chemistry Department, Diyala, Iraq

<sup>b</sup>University of Basrah, College of Pharmacy, Department of pharmaceutical Chemistry, Basrah, Iraq

<sup>c</sup>Al-Zahrawi University College, Department of Medical Laboratory Technics, Karbala, Iraq

<sup>d</sup>Ashur University College, Department of Biomedical Engineering, Baghdad, Iraq

<sup>e</sup>Prince Sattam Bin Abdulaziz University, College of Science and Humanities, Department of English, Al-Kharj, Alkharj, Saudi Arabia

<sup>f</sup>National University of Science and Technology, DhiQar, Iraq

<sup>g</sup>Sona College of Technology, Salem, Tamil Nadu, India

<sup>h</sup>University of Diyala, Science College, Chemistry Department, Diyala, Iraq

<sup>i</sup>Islamic Azad University, Department of Chemical Engineering, Arak Branch, Arak, Iran

<sup>j</sup>Islamic Azad University, Young Researchers and Elite Club, Gachsaran Branch, Gachsaran, Iran

### Abstract

Nanosensors work on the “Nano” scale. “Nano” is a unit of measurement around  $10^{-9}$  m. A nanosensor is a device capable of carrying data and information about the behavior and characteristics of particles at the nanoscale level to the macroscopic level. Nanosensors can be used to detect chemical or mechanical information such as the presence of chemical species and nanoparticles or monitor physical parameters such as temperature on the nanoscale. Nanosensors are emerging as promising tools for applications in agriculture. They offer an enormous upgrade in selectivity, speed, and sensitivity compared to traditional chemical and biological methods. Nanosensors can be used for the determination of microbe and contaminants. With the advancement of science in the world and the advent of electronic equipment and the great changes that have taken place in recent decades, the need to build more accurate, smaller and more capable sensors was felt. Today, high-sensitivity sensors are used that are sensitive to small amounts of gas, heat, or radiation. Increasing the sensitivity, efficiency and accuracy of these sensors requires the discovery of new materials and tools. Nano sensors are nanometer-sized sensors that, due to their small size and nanometer size, have such high accuracy and responsiveness that they react even to the presence of several atoms of a gas. Nano sensors are inherently smaller and more sensitive than other sensors.

**Keywords:** Nano sensors, organic, chemical, sensitivity, sensors, nanometer, molecular sensor.

### Resumo

Os nanossensores funcionam na escala “Nano”. “Nano” é uma unidade de medida em torno de  $10^{-9}$  m. Um nanosensor é um dispositivo capaz de transportar dados e informações sobre o comportamento e as características das partículas no nível da nanoescala para o nível macroscópico. Os nanossensores podem ser usados para detectar informações químicas ou mecânicas, como a presença de espécies químicas e nanopartículas, ou monitorar parâmetros físicos, como temperatura em nanoescala. Os nanossensores estão surgindo como ferramentas promissoras para aplicações na agricultura. Eles oferecem uma abrangente atualização em seletividade, velocidade e sensibilidade em comparação com os métodos químicos e biológicos tradicionais. Os nanossensores podem ser usados para a determinação de micróbios e contaminantes. Com o avanço da ciência no mundo e o advento dos equipamentos eletrônicos e as grandes mudanças ocorridas nas últimas décadas, sentiu-se a necessidade de construir sensores mais precisos, menores e mais capazes. Hoje, são usados sensores de alta sensibilidade que são sensíveis a pequenas quantidades de gás, calor ou radiação. Aumentar a sensibilidade, eficiência e precisão desses sensores requer a descoberta de novos materiais e ferramentas. Os nanossensores são sensores de tamanho nanométrico que, devido ao seu tamanho pequeno e tamanho nanométrico, possuem uma precisão e capacidade de resposta tão altas que reagem até mesmo na presença de vários átomos de um gás. Os nanossensores são inerentemente menores e mais sensíveis do que outros sensores.

**Palavras-chave:** nanossensores, orgânico, químico, sensibilidade, sensores, nanômetro, sensor molecular.

\*e-mail: ehsankianfar775@gmail.com; ehsan\_kianfar2010@yahoo.com

Received: October 23, 2022 – Accepted: March 20, 2023



This is an Open Access article distributed under the terms of the Creative Commons Attribution License, which permits unrestricted use, distribution, and reproduction in any medium, provided the original work is properly cited.

## 1. Introduction

Chemical sensors, Nano sensors and biosensors are among the most popular topics in chemistry. This issue can be concluded from the volume of studies and also the variety of methods and techniques used in this field (Martínez-Mañez and Sancenón, 2003; Kim and Quang, 2007; Han et al., 2009). This is especially due to the new needs that have arisen in medical diagnostics, environmental decomposition, food decomposition and production monitoring of some products (James et al., 1995; Motsenbocker et al., 1993; Jung et al., 2011). For example, sensors can be used to detect illicit drugs, toxins, and chemical warfare agents. Controlling the function of drugs in the body is another practical aspect of biosensors that has received much attention in recent years (Janata and Bezegh, 1988; Kaniusas et al., 2004; Adhikari and Majumdar, 2004; Madou and Morrison, 1989). In designing a sensor, scientists of different sciences such as biochemistry, biology, electronics, different branches of chemistry (organic, decomposition, physics and surface) and branches of physics (mechanics, light, thermodynamics) are involved (Gauglitz et al., 1993; Hisamoto and Suzuki, 1999; Tiwari and Anthony, 2014; Wu et al., 2016). The main part of a chemical or biological sensor is its sensor element. The sensor element is in contact with a detector. The sensor element is responsible for identifying and linking to the target analytic (target species) in a complex sample. The detector then converts the chemical signals generated by the bonding of the sensor element to the analytic into a measurable output signal (Bonyani et al., 2016; Lee and Park, 2011; Dahman, 2017; Zhuiykov, 2012; Xu and Zhang, 2010; Hou et al., 2010). Biosensors rely on biological components such as antibodies. Enzymes, receptors, or cells can also be used as sensors. With recent advances in chemistry, and in particular the targeted and precise synthesis of molecules (and macromolecules) in organic chemistry, a sensor element can be found for analyses for which there are no natural receptors. This designed molecule can be used as a sensor component in a chemical sensor (Chemo sensor) and linked relatively specifically to the decomposed species (Vunain and Mishra, 2018; Gupta et al., 2015; Zhang et al., 2018).

## 2. Chemical Sensors

A sensor is a chemical device or device that is able to reversibly communicate with analyses. This relationship

is accompanied by a change in a quantity being measured, such as a change in color or fluorescence, and so on.

### 2.1. Some detection methods in chemo sensors

- 1) Fluorescence Detection
- 2) Colorimetric Detection
- 3) Electrochemical Detection

Each of these methods has advantages and disadvantages. Fluorescence is a method with very high sensitivity and is used in a wide range (Tang et al., 2019; Xiao et al., 2020; Kearns et al., 2017). The colorimetric method is similar to fluorescence but has a lower sensitivity. In the electrochemical method, the sensitivity is high and the equipment required is simple, but it is used for certain species (Madou and Morrison, 1989; Gauglitz et al., 1993).

#### 2.1.1. Principles of chemical sensors based on fluorescence

Chemical sensors must have two main components, fluorophore (Fluorophore) as part of the signal generator and receiver of this signal. In the presence of the analytic, the receptor attaches to it, and the fluorophore exhibits a signal change in color or fluorescence. The components of a chemical sensor are shown in Figure 1. In a simple example, the emission of a photon or fluorescence occurs following the excitation of an electron from the highest occupied orbital (HOMO) to the lowest occupied orbital (LUMO) in a molecule (Hisamoto and Suzuki, 1999; Tiwari and Anthony, 2014). In Figure 2a, as you can see, a pair of unbounded electrons is located adjacent to the fluorophore molecule, and the energy of this orbital is located between the HOMO orbital and the LUMO orbital of the fluorophore. By emitting light, the electron is excited from the HOMO orbital to LUMO, whereupon one of the unbounded electrons is transferred to the HOMO fluorophore orbital cavity created by the electron excitation. The excited electron is transferred to the non-bonded orbital instead of returning to the ground state, turning off the fluorescence. Such a mechanism is called photo induced electron transfer (PET). Figure 2b shows that if the same pair of unbounded electrons participates in a bonding interaction, the energy of this orbital decreases and the transfer of electrons to the Homo orbital cavity is prevented. The electron excited from the LUMO orbital returns to the ground state with the emission of radiation, which is called a mechanism (Chelation-Enhanced Fluorescence-CHEF).

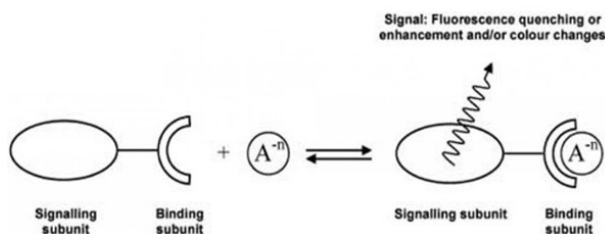

Figure 1. Organic chemical sensor components (Adhikari and Majumdar, 2004).

## 2.2. Anionic sensors

### 2.2.1. Anionic sensor to detect fluoride ions through fluorescence

Nano silica functionalized by the organic molecule of Figure 3b shows fluorescence change in the presence of fluoride anion in aqueous solution. As shown in Figure 3a, fluorescence does not change in the presence of other anions such as bromine, iodine, and sulfate. However, in the presence of fluoride anions and the formation of hydrogen bonds with nitrogen hydrogens, fluorescence changes (Jimenez-Falcao et al., 2020; Ehgartner et al., 2016; Wang et al., 2017; Caon et al., 2017). Here, due to the transfer of non-bonded electrons by nitrogen to the fluorophore part of this sensor, the fluorescence is turned off.

### 2.2.2. Sensor to detect phosphate anion by calorimetry

The sensor uses a derivative of fluorescein to detect phosphate anions. Its fluorescein fraction shows a certain color. This sensor, as shown in Figure 4, contains hybrid materials with nanoscale acceptor sites for anion bonding. In the absence of the phosphate anion, the anionic derivative of fluorescein is placed in the mesoporous Nano silica cavity (Srivastava et al., 2018; Vikesland, 2018;

Fuertes et al., 2016; Arndt et al., 2020). In the presence of the phosphate anion, this derivative is released into the medium, which is clearly shown in Figure 4 as the cause of the color change. Therefore, the signal generation is actually due to the release of fluorescein derivative into the environment.

## 2.3. Cation sensors

### 2.3.1. Sensor to detect copper cation through calorimetry

This sensor is designed to detect copper cations. This sensor is made by functionalizing silica nanotubes using organic molecules. Figure 5a shows the deposition color of functionalized silica nanotubes without the presence of cations, Figure 5b shows the presence of copper cations, and Figure 5c shows the presence of other cations. Figure 5d also shows how the copper interacts with the acceptor site on silica nanotubes.

### 2.3.2. Sensor to detect mercury cation through fluorescence

A report presents a cationic chemical sensor for lead ions based on Core-Shell silica nanoparticles on iron oxide (Shen et al., 2017; Mahmoudpour et al., 2019;

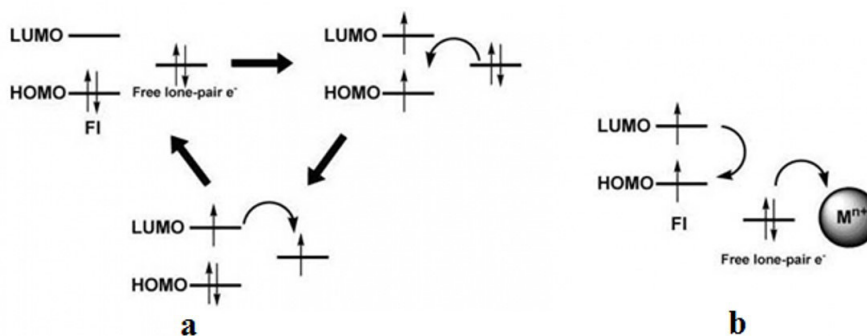

**Figure 2.** Mechanism of chemical sensors (Adhikari and Majumdar, 2004).

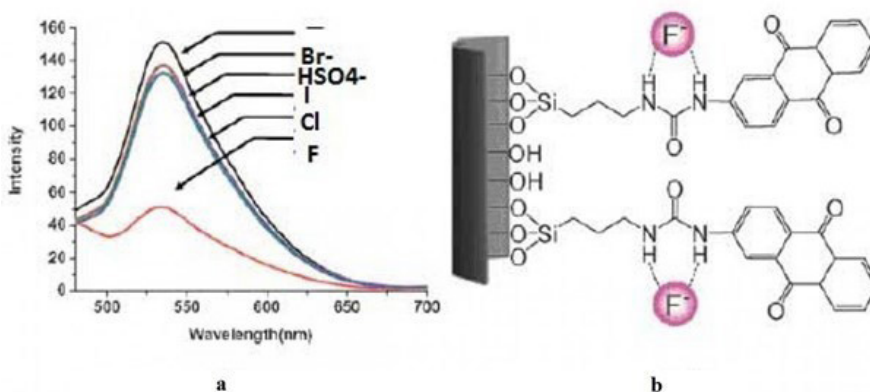

**Figure 3.** (a) Change in fluorescence emission in the presence of different anions (b) Nano silica functionalized by organic molecules (Adhikari and Majumdar, 2004).

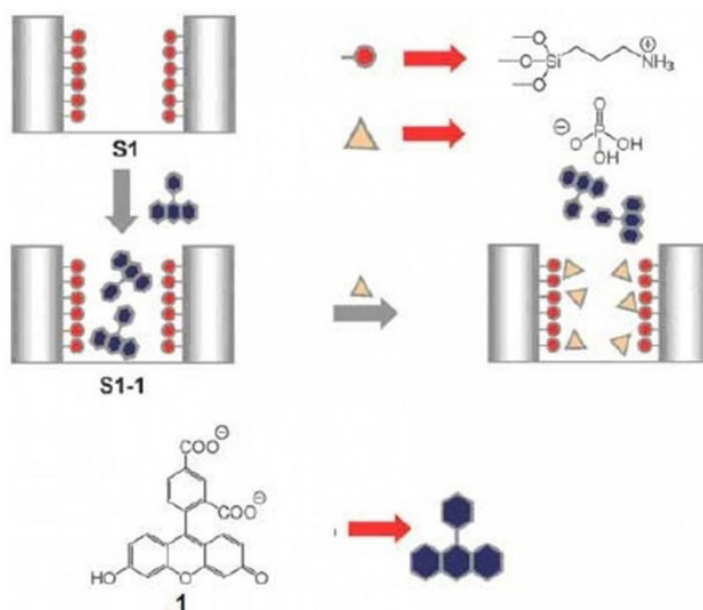

Figure 4. Sensor for phosphate anion detection (Adhikari and Majumdar, 2004).

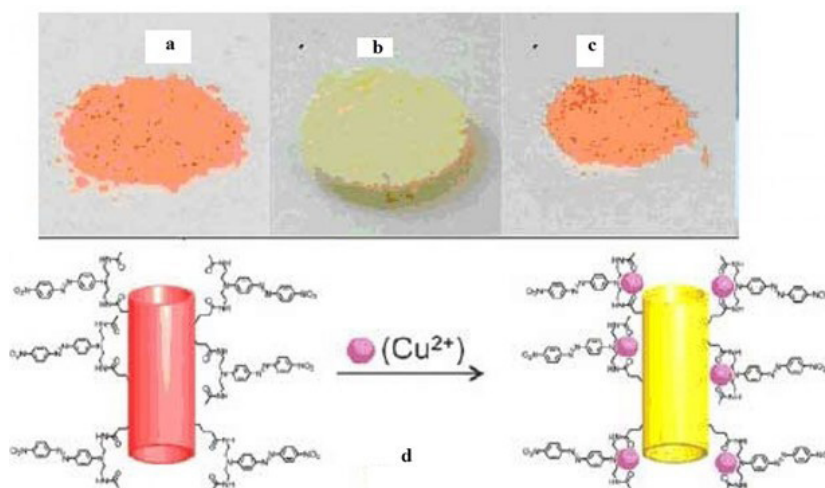

Figure 5. Sensor for detecting copper cation through calorimetry (Adhikari and Majumdar, 2004).

Borgognoni et al., 2018; Sun et al., 2019; Wang et al., 2017). In this work, the core-shell nanostructure is functionalized with an organic compound. Figure 6 shows the fluorescence change of this sensor. The organic molecule emits radiation in the presence of cations.

### 2.3.3. Chemo dosimeter Irreversible Chemical Sensors

These sensors refer to sensors that react irreversibly with analyses and the cause of color change or fluorescence change in such sensors is a change in the structure of the organic species. This change in these sensors is irreversible (Huang et al., 2021).

#### 2.3.3.1. Gold nanoparticle-based chemo dosimeter for nitrate anion detection by calorimetry

Functionalized gold nanoparticles are used to identify distinctive optical properties are used to identify various systems such as DNA, proteins, small molecules, metal cations, and cancer cells. Figure 7 shows a Como dosimeter to identify nitrate anions. In this case, in the presence of nitrate anion, a two-molecular reaction occurs between two functionalized gold nanoparticles, causing the two molecules to pair and change color. This color change is shown in Figure 3b in the presence of different concentrations of nitrate anion.

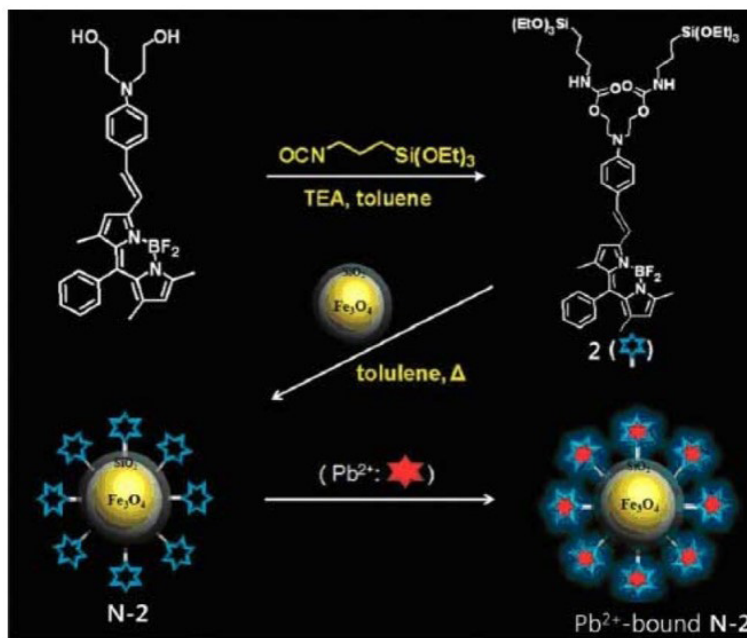

**Figure 6.** Sensor for detecting lead cation by fluorescence (Agrawal et al., 2018).

### 2.3.3.2. Nano silica-based chemo dosimeter for detection of copper cation by fluorescence and calorimetry

This Chemo dosimeter is designed to detect copper cations. The system has the dual properties of color change and fluorescence in the presence of copper cation as a chemo dosimeter (Agrawal et al., 2018; Bandodkar et al., 2016; Bott and Franz, 2019; Ntim et al., 2018). In the presence of other different cations, as you can see, it does not show any fluorescence change. As shown in Figure 8, the presence of copper cation changes the structure of the molecule, which causes a change in color and fluorescence.

## 3. Molecular Sensors

### 3.1. Sensor to detect glucose

As you can see in Figure 9, they have designed a sensor to detect goulash that does not show fluorescence due to the transfer of non-bonded nitrogen electrons to the anthracene fraction. But in the presence of saccharide and the interaction of saccharide with boron, boron has a negative charge. In this case, the formation of a positive charge on nitrogen increases. By forming a hydrogen bond, a positive charge is formed on the nitrogen and prevents electron transfer and shows fluorescence change (Martínez-Mañez and Sancenón, 2003; Kim and Quang, 2007; Han et al., 2009).

### 3.2. Nanoparticle-based molecular sensor used to detect trinitrotoluene

A sensor designed to detect TNT (Trinitrotoluene) is shown in Figure 10a. This sensor is composed of several polymer filaments that contain conjugate bonds. Each unit of this polymer filament is shown in Figure 10b. Functionalized ruthenium metal nanoparticles have been

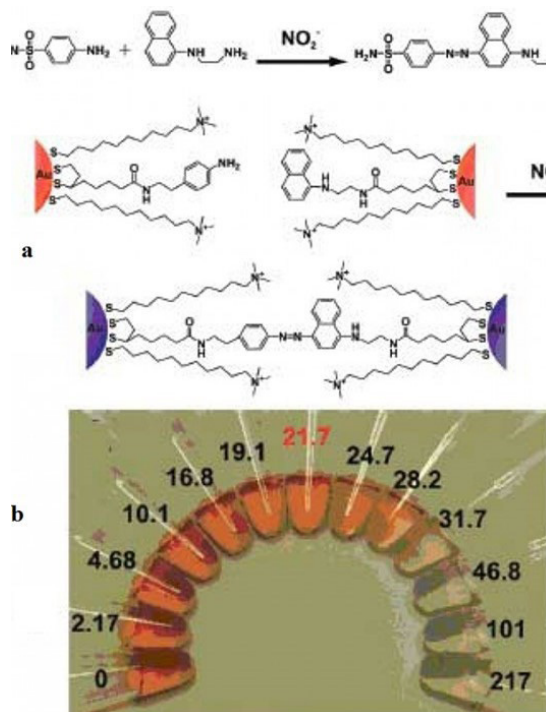

**Figure 7.** Anionic Chemo dosimeter (Agrawal et al., 2018).

used to detect trinitrotoluene, which is based on a change in the fluorescence of the pyrene species located on the nanoparticles in the presence of TNT (Figure 10c).



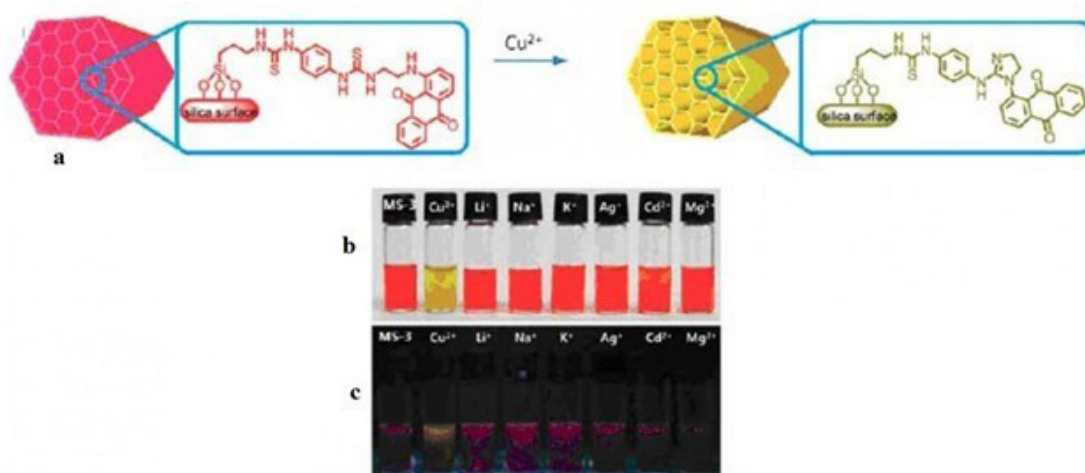

**Figure 8.** Chemo dosimeter detection of copper cation based on Nano silica (Adhikari and Majumdar, 2004).

### 3.3. Biological and environmental applications of sensors based on magnetic nanoparticles

Oregano-mineral hybrids of magnetic nanoparticles can selectively identify and isolate molecules in biological and environmental samples. Isolation of the main factor of the disease from the blood has been considered in a large number of clinics (Zhang et al., 2019; Hunter et al., 2013; Xu et al., 2016; Lin et al., 2020; Chen et al., 2014; Freeman et al., 2013). Membranes, which are limited to small molecules, are commonly used to directly separate small molecules such as urea, potassium, and serotonin (Ehgartner et al., 2016; Chen et al., 2014; Tahmasebi et al., 2021). Biomaterials are large and cannot be separated using these membranes. In a study to separate lead from human blood, nickel nanoparticles labeled with molecule 1 were used. As shown in Figure 11, a change in fluorescence is observed with the adsorption of lead by acceptor sites. Due to its magnetic nature, this nanoparticle absorbs all the lead in the blood after 30 minutes and can be separated using a magnet. Uranium is a radioactive metal found in nature. This species is sometimes found in natural waters, which is dangerous to human health. Therefore, the design of sensors that are able to detect and isolate this species has received much attention (Smaisim et al., 2022; Kadhim et al., 2023; Tahmasebi et al., 2021). In one study, they were able to easily identify and separate these particles using magnetic nanoparticles optimized with bisphosphonates. Figure 12 shows the separation method well (Xu et al., 2016).

## 4. Chemical Sensors

A chemical sensor is a sensory receptor that detects specific chemical stimuli in the environment. The use of chemical sensors is one of the most advanced methods in decomposition chemistry, which makes it possible to quantitatively measure different species instantly (Mahmoud et al., 2021; Bokov et al., 2022). Existing electronic and optical technology has made these tools more

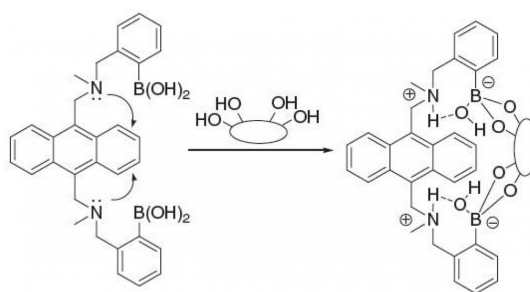

**Figure 9.** Sensor for glucose detection (Agrawal et al., 2018).

widespread and advanced. In designing a sensor, scientists from different sciences such as biochemistry, biology, electronics, various branches of chemistry and physics are involved. The main part of a chemical or biological sensor is the sensor element that is in contact with a detector. This element is responsible for identifying and linking to the species in a complex specimen. After this bonding, the detector converts the chemical signals generated by the bonding of the sensor element to the target species into a measurable output signal (Mahmoud et al., 2022a, b; Raya et al., 2022; Bahadoran et al., 2022). Biosensors rely on biological components such as antibodies; Enzymes, receptors, or whole cells can be used as sensors. Chemical sensors include a sensor layer that generates an electrical signal by the interaction of a chemical species (analytic) with this layer. This signal is then amplified and processed. Therefore, the operation of chemical sensors consists of two main stages, which are: detection and amplification. The device that performs this process is generally called a chemical sensor. This device collects information about the chemical composition of its operating environment and transmits it to the processor as an optical or electrical signal (Mahmoud et al., 2022; Smaisim et al., 2023; Fattah et al., 2023). Figure 13 shows the mechanism of action of a chemical sensor. A concrete example of these sensors in nature is the human nose, where a nerve signal is generated

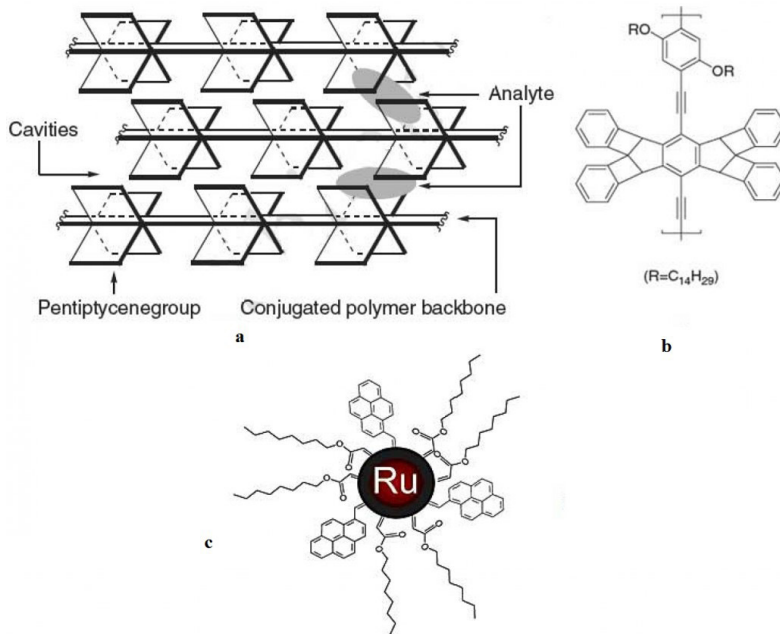

**Figure 10.** Sensor for detection of trinitrotoluene (Agrawal et al., 2018).

by the collision of material molecules with nerve cells and then amplified and sent to the brain. Ideally, a chemical sensor is in direct contact with the sample and provides good results in low time, precision and high selectivity. The sensor and sensing process are usually designed to require sampling, dilution, reagent, and so on. The ease of use of these sensors has led to their use in a variety of fields; In clinical chemistry, it is used to control the causes of diseases such as diabetes, to detect and track specific gases such as oxygen and carbon monoxide, and so on. Sensors are also used to determine the amount of environmental pollutants, control and process of the food industry. An important feature of chemical sensors is that they can be made in very small sizes. This shrinkage makes it possible to measure different species, even in the cells of living organisms.

#### 4.1. Types of chemical sensors

Chemical sensors are divided into four categories based on the converter used to convert the chemical change into a process able signal: thermal sensors, mass sensors, electrochemical sensors (potentiometric, aerometry, conductivity), and optical sensors (Kianfar, 2023; Hachem et al., 2022; Abdelbasset et al., 2022).

##### 4.1.1. Heat sensors

Heat is a common feature of chemical reactions; Accordingly, a suitable physical factor for sensing, detecting and measuring temperature changes generated during a reaction is proportional to changes in analytic concentration. To do this, only a small amount of solution is needed to control the temperature. Enzymatic reactions are among the reactions that can be used as selective chemical reactions to generate heat; For this reason, in most heat

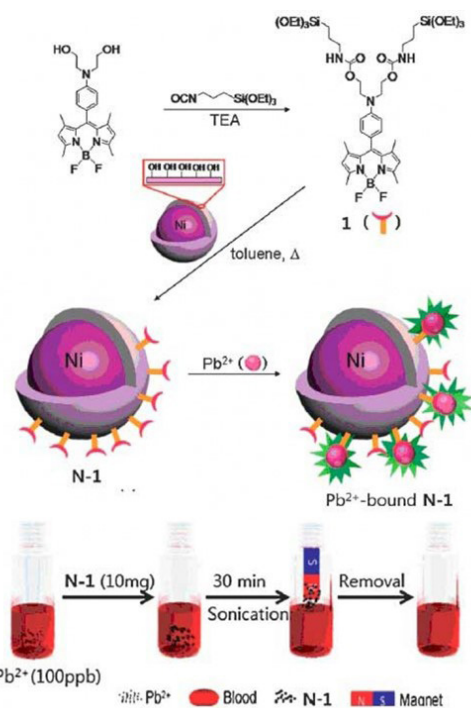

**Figure 11.** Synthesis of magnetic Nano silica to separate lead from blood (Al Sarraf et al., 2022).

sensors, enzymes are used for sensory action. Enzyme transistors are a class of sensors that use undercurrent systems for calorimetry. In these systems, the enzymatic reaction takes place in a column containing an enzymatic

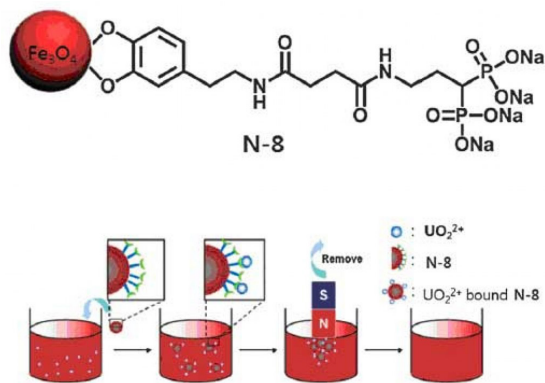

Figure 12. Sensor for uranium detection (Al Sarraf et al., 2022).

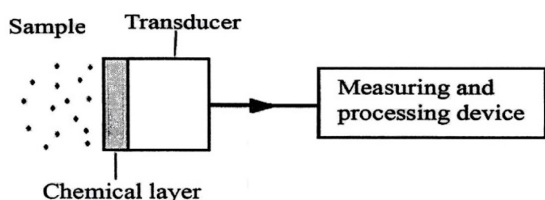

Figure 13. Schematic of a chemical sensor (Al Sarraf et al., 2022).

reagent, and the output heat is measured at the end of the column at the outlet of the sample stream and solution. Two types of heat detectors are used in the construction of heat sensors; Among these detectors, Thermistor is the most common one, which is more used due to its cheap price, availability, stability and high sensitivity. Pyroelectrics are another type of converter used in heat sensors that are very sensitive to heat sensors. They can be used to track the heat absorbed by the gas layer (Jasim et al., 2022; Suryatna et al., 2022; Omer et al., 2022). Another type of heat sensor is a biosensor made of silicon chips, which are more sensitive than conventional thermistor sensors. Applications of heat sensors include the following: Cholesterol determination, measurement of the catalytic properties of stabilized cells, control of biological processes, measurement of water in food, etc. Figure 14 shows a heat sensor.

#### 4.1.2. Mass sensors

Like measuring the heat generated by a reaction, measuring mass change can also be used as a suitable measure for chemical sensors. This property can be used for reactions that result in a change in net mass due to the release of a selective catalytic reactor. These sensors have two important features; First, they can be used in the liquid phase, and second, because they are used in the gas phase and selectivity in this phase, they are used for immunoassay applications. There are two major types of mass sensors, the first using piezoelectric oscillators and the second using surface acoustic waves (Sun et al., 2019). In general, quartz and polyvinyl fluoride can be used to make oscillators. Quartz is the most common material

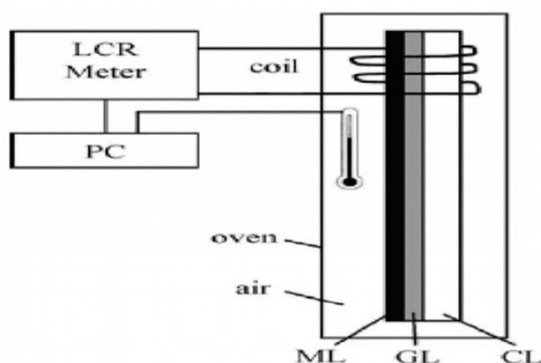

Figure 14. A dual layer heat sensor, ML, magnetic resonance layer, GL, and adhesive layer, CL (Al Sarraf et al., 2022).

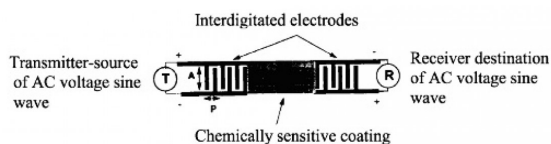

Figure 15. An example of a SAW type mass sensor (Al Sarraf et al., 2022).

used for mass oscillators such as Crystal Microbalance. Quartz has heterogeneous crystals that lack a center of symmetry and mechanically deform when exposed to an electric field. As a result, the crystal is mechanically vibrated using an oscillating electric potential. Each crystal has a resonant vibrational frequency that can be adjusted under the influence of its environment; The typical frequency of this vibration is about 10 MHz; In practice, the vibration frequency of a piezoelectric crystal is proportional to the mass of the crystal and other things that cover the surface of the crystal. In addition to quartz crystals, other materials such as polyvinyl fluoride are also used as integrated arrays. A schematic of a mass sensor is shown in Figure 15.

#### 4.1.3. Electrochemical sensors

The oldest and largest group of chemical sensors are electrochemical sensors; The response generated in these sensors is due to the interaction between chemistry and electricity. Today, many of these sensors are commercially available and available on the market, and many are in development. Electrochemical sensors are divided into three categories (Lin et al., 2020; Chen et al., 2014; Freeman et al., 2013):

Potentiometric sensors (cell voltage measurement), amphoteric sensors (cell current measurement), conductivity sensors (conductivity measurement).

#### 4.1.4. Chemical optical sensors

Chemical optical sensors are among the youngest chemical sensors. There are several reasons to pay close attention to these sensors:



- The optical devices required for use in these sensors are already developed and can be easily used in chemical sensors. They have many applications for remote control of processes, which makes their use more secure. They can be made in small sizes and even placed on the tip of an optical fiber (Lin et al., 2020; Chen et al., 2014; Freeman et al., 2013);
- Optical-chemical sensors, like electrochemical sensors, use extensive spectroscopy knowledge that can be easily converted to remote sensors. Optical sensors are used in a variety of ways such as measuring absorption, fluorescence and luminescence over a wide range of wavelengths;
- Chemical-optical sensors are divided into several categories based on their application, such as: Immunosensor, pH sensors, gas optical sensors, humidity sensors, ionic optical sensors, sensors used in petro chemistry, etc.

#### 4.1.5. Materials used to make sensors

The materials used to make the sensors can be divided into two categories: classical and polymer (Lin et al., 2020; Chen et al., 2014; Freeman et al., 2013).

##### 4.1.5.1. materials classical

The basis of solid state sensors is the electrical response to the chemical environment. For example, electrical properties change with the presence of a liquid or gas phase; These changes are used to identify chemical species (Lin et al., 2020; Chen et al., 2014; Freeman et al., 2013). Although silicon chemical sensors such as the Field Effect Transistor (FET) have been developed, the cost and technology required to manufacture them, as well as problems such as reproducibility, stability, sensitivity, and selectivity, have limited their use. Metal oxide semiconductor sensors such as compact powders and SnO<sub>2</sub> thin films also have a catalytic activation effect.

##### 4.1.5.2. polymer

Polymeric materials have been widely used in sensor technology over the past decade. These materials have many advantages for use in the manufacture of sensors, including the following:

- Polymers can be deposited on a variety of substrates;
- Some chemical species can be chemically deposited on polymer substrates to reduce the amount of reactant leakage into the sample solution;
- Variety of polymers in terms of structural properties such as having side chains or being charged or neutral particles, etc., which create the appropriate physical and chemical properties for the sensor;
- The possibility of dissolution or even uniform dispersion of the chemical detector in the polymer tissue is provided;
- Mechanical stability of polymers allows long-term use of the sensor and its high stability; The polymer structure in some cases improves properties such as selectivity and sensitivity;
- Polymers are relatively inexpensive materials and their manufacturing techniques are simple and easy and

do not require special conditions. In some cases, even under normal laboratory conditions, the polymerization required to make a sensor layer is performed (Lin et al., 2020; Chen et al., 2014; Freeman et al., 2013).

Polymers and materials suitable for making sensors must have a number of special properties, which include (Lin et al., 2020; Chen et al., 2014; Freeman et al., 2013):

- Detector solubility in polymer tissue;
- Appropriate lifespan;
- Lack of crystallization or migration or reorientation of species;
- No effect of aging and depreciation;
- Resistance to chemicals such as acids, bases and oxidants;
- Transparency against light;
- Biocompatibility (non-toxic substances);
- No inherent color or luminescence (in use as a background).

A polymer fabric is used to make such sensors. A compound with optical properties is stabilized as a sensitizer inside the polymer substrate (mass sensor) or on its surface (surface sensor). Therefore, the polymer only acts as a retaining agent or a solid substrate. It should be noted that in these sensors, the polymer membrane used, in addition to holding the detector in a specific and fixed place, also has other functions. Membrane permeability properties can lead to the repulsion of other species or ions that are considered to be interfering. For example, hydrophobic membranes are used to repel non-volatile materials in sensors used to measure the concentration of gases in water (Lin et al., 2020; Chen et al., 2014; Freeman et al., 2013).

## 4. Manufacture of Nano-sensors for Water Treatment Applications

In recent years, environmental pollution caused by the entry of heavy metal ions and other toxic elements into the environment has become a major problem. Among environmental pollutants, water pollution is a much more serious threat to human health. Water security is threatened by the introduction of a wide range of chemical pollutants produced by various industries and agriculture, such as hydrocarbons, mineral gases, and especially toxic metals such as mercury, chromium, cadmium, arsenic, lead, etc. These toxic metals cause long-term damage to biological systems and can disrupt biological life, even at the cellular level. Uncontrolled discharge and monitoring of garbage, use of agricultural herbicides, pesticides, insecticides and effluent disposal all play a major role in these contaminants. It is not possible to use groundwater directly in many parts of the world due to its high salt concentration and hazardous contaminants. The source of these dangerous pollutants is the industrialization of different countries without proper and sufficient control over mineral wastes, which has caused unwanted effluents and debris to enter the soil and water. Another important factor is the growing population of the world and climate change, which has complicated the problem of water pollution and has created many problems to eliminate this pollution.

Therefore, in order to use unsuitable groundwater for drinking purposes, there is a need for treatment operations using new high-efficiency technologies (Lin et al., 2020; Chen et al., 2014; Freeman et al., 2013). Nanotechnology has all the features needed to be used in the water treatment process and is known as a promising option to solve many problems in the water treatment and purification process. Environmental applications of nanotechnology are divided into three general groups, including (1) the production of sustainable and environmentally friendly products such as wetting, (2) the treatment of toxic pollutants, and (3) the production of sensors and detectors that protect the environment. Nanomaterials are used as sensors to control water quality due to their high specific surface area for adsorption, high photocatalytic activity, antimicrobial properties for disinfection and other unique optical and electron properties (Xu et al., 2016). So far, several methods have been proposed for the detection of heavy metals in water, but none of them are fully capable of detecting heavy metal ions and microbial or organic pathogens. Therefore, there is an urgent need to develop new and advanced sensors to detect biochemical contaminants with very low concentrations in water. A sensor is a type of energy converter that has the ability to detect certain properties and changes related to its environment. The results of the changes detected by the sensors are displayed as a signal (electrical or optical). There are many types of sensors and they have a wide range of applications in various fields. In general, core-shell nanomaterials are a combination of different materials such as dielectrics, metals, semiconductors, and pigments. In core-shell nanomaterials, one material acts as a core and another as a shell. Depending on the application, core-shell nanomaterials can take many forms, such as Nano pores, nanowires, and nanosats. There is another type of core-shell nanostructure in which the core of a very small metal nanoparticle with dimensions of 10-50 nm such as gold or silver, and the shell is made of silica. These nanostructures dramatically increase the chemical stability of colloids and improve the luminescence properties of some systems. Therefore, these nanostructures are used to identify metal ions in water. The method of synthesis of nanocomposites with silver-silica core-shell structure (SiO<sub>2</sub> @ Ag Core-shell Nanocomposites), gold-silica (SiO<sub>2</sub> @ Au Core-shell Nanocomposites) and single-walled carbon nanotubes used in the water treatment process will be discussed.

#### 4.1. Nanocomposite with core-shell structure of silver-silica

The synthesis of these nanocomposites consists of two steps. First the silica particles are synthesized by the Stober method and then the silver particles are coated on them. The advantage of this method is the presence of unidentified charges on the surface of silica particles and silver ions. Therefore, silver nanoparticles are adsorbed on the surface of silica particles by electrostatic attraction. Silver nitrate is reduced in the presence of silica particles using trisodium citrate. The particles produced after centrifugation are washed with water. The precipitated yellow color is then redistributed in water. The thickness of these nanostructures increases with the repetition of the

second stage of the process. It is also possible to control the thickness of the coating by changing the reaction conditions such as the amount of silica particles added (Xu et al., 2016).

#### 4.2. Nanocomposite with gold-silica core-shell structure

To prepare these particles, silica particles are first activated using 3-aminopropyl ether-ethoxysilane (APTES). APTES molecules contain OH at one end and NH<sub>2</sub> at the other. Thus, these molecules have the ability to bind to silica and gold via oxygen and nitrogen atoms, respectively. The resulting solution is stirred vigorously for 4 hours at 65 °C and then centrifuged. The resulting precipitate is washed off with water. In the next step, the solution of gold, sodium hydroxide and functionalized silica particles in water is stirred for 10 minutes at 75 °C and gold grains are formed in silica particles. Finally, the final solution is centrifuged, washed with water and redistributed in water (Lin et al., 2020).

#### 4.3. Single-walled carbon nanotubes

Conventional solid state sensors used to detect NO<sub>2</sub> and NH<sub>3</sub> typically operate at temperatures above 400 °C, and polymers are not widely used due to their limited sensitivity. On the other hand, sensors made of single-walled carbon nanotubes are highly sensitive and react quickly at room temperature. Also, these nanomaterials can be metallic or semiconductor depending on their radius and chirality. To produce Nano sensors based on single-walled carbon nanotubes, single-walled carbon nanotubes with a diameter of 4 nm are dispersed in various solvents such as acetone, chloroform and dimethylformamide. The best solvent for uniform distribution of single-walled carbon nanotubes is dimethylformamide. Before coating single-walled carbon nanotubes on glass plates, a pre-treatment step on glass plates is performed by APTES to prevent the nanotubes from separating from the glass plates. During this pre-operation, the glass plates are washed with water and acetone and immersed in 2% APTES solution for 2 hours and finally dried at room temperature. Methods such as sol-gel are used to coat single-walled carbon nanotubes from the suspension containing these nanotubes on glass slides (Chen et al., 2014).

## 5. Identification of Heavy Metals in Water with Core-shell Nanocomposite Structures and Nanoparticles (Nano Sensors)

The presence of some metal ions such as zinc (Zn<sup>+2</sup>) is essential for maintaining the normal function of cells; While heavy metal ions such as cadmium, mercury and lead have destructive effects on human health and cause various diseases such as cancer. In this section, Nano sensors synthesized from metal nanoparticles are used to detect these contaminants. How to completely and effectively remove undesirable metals from the water system is a huge challenge. Toxic heavy metals in industrial effluents include iron, copper, nickel, mercury, cadmium, lead and chromium. Metal nanoparticles have very strong and

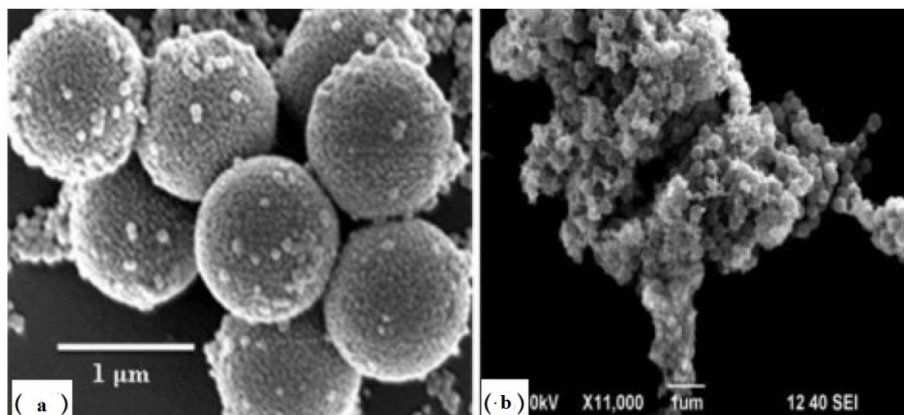

**Figure 16.** (a) TEM image of nanocomposites with gold-silica core-shell structure and (b) SEM image of aggregate core-shell particles with the addition of 0.01 ppm of cadmium ions ( $\text{Cd}^{2+}$ ) (Agrawal et al., 2018).

desirable absorption properties in the ultraviolet-visible region of the electromagnetic spectrum. The reason for this is the cumulative electron interactions between metal atoms and electrons. In the case of gold and silver nanoparticles, surface Plasmon intensification is one of their most attractive properties, as it creates unique optical properties in the visible light spectrum. Plasmon is the cumulative oscillation of electrons in a metal conduction layer as high-energy electrons pass through. Recently, the tendency to use composite materials including metal nanoparticles and polymers as lattices has increased significantly. By adding metal nanoparticles to the polymer, new and unique properties are created and the range of properties is significantly expanded. Nanocomposites with a core-shell structure of gold-silica have a more advanced surface Plasmon resonance band than gold nanoparticles; Therefore, it is more sensitive to detect very small amounts of heavy metals in drinking water. Nanocomposites with a gold-silica core-shell structure accumulate when heavy metal ions collide to detect the presence of these contaminants (Lin et al., 2020; Chen et al., 2014; Freeman et al., 2013). TEM and SEM images of nanocomposites with gold-silica core-shell structure and aggregated core-shell particles with the addition of 0.01 ppm of cadmium ions ( $\text{Cd}^{2+}$ ) are shown in Figure 16. Also, with the presence of these ions, changes occur in the location of the Plasmon adsorption band due to the chemical adsorption of these ions on the surface of the nanocomposite containing gold. The changes in the surface Plasmon resonance peaks of Nano sensors with the entry of cadmium ions are shown in Figure 17. Similar results were obtained for cadmium ions when zinc and lead ions were present in water. In other words, with the presence of these ions, a partial transition in the bands towards longer wavelengths will occur. Suspensions containing gold nanoparticles show a strong red color due to the absorption of surface Plasmon. When there are zinc and lead ions, there is no change in their red color. Discoloration occurs only when electrons are transferred from adsorbed ions to metal particles. This phenomenon increases the density of free electrons in the metal conduction band

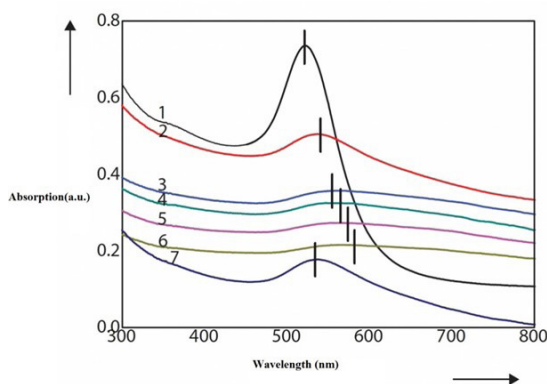

**Figure 17.** Changes in the surface plasmon resonance peaks of nanosensors with the entry of cadmium ions: (1) gold, (2) gold-silica, (3) gold-silica +0.1 ppm cadmium ion, (4) gold-silica + 1 ppm ion Cadmium, (5) gold-silica 2ppm + cadmium ion, (6) gold-silica +5 ppm cadmium ion, (7) gold-silica +10 ppm cadmium ion (Agrawal et al., 2018).

and increases the plasma frequency of the metal. Raman spectroscopy and surface enhanced Raman spectroscopy are other tools for investigating changes in nanocomposites with a gold-silica core-shell structure when they interact with cadmium ions. With the presence of cadmium ions in the ppm range, the intensity of the gold peak in the Raman spectrum decreases. Also, sensors made of gold nanowires are capable of detecting mercury ions in water up to ppb.

## 6. Conclusion

1. In this paper, we reviewed chemical sensors based on organic molecules to identify toxins and neutral cations, anions, and molecules using colorimetric and fluorescence systems. Nano silica as a solid phase is suitable for creating hybrid nanomaterials functionalized with organic molecules. Nano-silica-based organic and mineral hybrids show high selectivity

for the identification of anions, and natural compounds and toxic metal ions. Examples of the use of magnetic nanoparticles functionalized with organic species as chemical sensors with biological and environmental applications are also discussed below;

- The main part of a chemical or biological sensor is its sensor element. The sensor element is in contact with a detector and is responsible for identifying and linking to the target analytic (target species) in a complex sample. The detector converts the chemical signals generated by the bonding of the sensor element to the analytic into a measurable output signal. In designing a sensor, scientists of different sciences such as biochemistry, biology, electronics, different branches of chemistry (organic, decomposition, physics and surface) and branches of physics (mechanics, light, thermodynamics) are involved. Chemical sensors, Nano sensors and biosensors are among the most popular branches of chemistry; This issue can be concluded from the volume of studies and also the variety of methods used in this field. This is especially due to the new demands and needs that have arisen in medical diagnostics, environmental degradation, food decomposition, and production monitoring of some products. For example, sensors can be used to detect illicit drugs, toxins, and chemical warfare agents;
- Nano sensors are nanometer-sized sensors that are extremely sensitive and have selective performance capabilities. Nanomaterials are used as sensors to control water quality due to their properties such as high specific surface area for adsorption, high photocatalytic activity, antimicrobial properties for disinfection and other unique optical and electron properties. The most important feature of Nano sensors is their very high sensitivity and detection power. Various nanoparticles such as carbon nanotubes, gold nanoparticles, quantum dots, magnetic nanoparticles and nanocomposites with core-shell structure are used as Nano sensors. Among the most important applications of Nano sensors are determining the amount of nitrate and phosphate in water, determining the amount of dissolved oxygen in water, monitoring pH, determining the amount of heavy elements in water, measuring and detecting pesticides and insecticides, monitoring the amount of microbial contamination and so on. The optical properties of nanoparticle-based sensors are used to detect contaminants in water. Another application of Nano sensors is to monitor the distribution and quality of water. The reason for this is the loss of water from leaking pipes and pipes. Here, the method of synthesis of nanocomposites with core-shell structure of silver-silica, gold-silica and single-walled carbon nanotubes used in the water treatment process was completely proposed. Metal nanoparticles such as gold and silver have very strong and desirable absorption properties in the ultraviolet-visible region of the electromagnetic spectrum, which is due to the cumulative electron interactions between metal atoms and electrons. Nanocomposites with a gold-silica core-shell structure have a more advanced surface Plasmon resonance bond than gold nanoparticles and are therefore more sensitive

to detecting very small amounts of heavy metals in drinking water. Nanocomposites with a gold-silica core-shell structure accumulate when heavy metal ions collide to detect the presence of these contaminants.

## References

- ABDELBASSET, W.K., JASIM, S.A., BOKOV, D.O., OLENEVA, M.S., ISLAMOV, A., HAMMID, A.T., MUSTAFA, Y.F., YASIN, G., ALGUNO, A.C. and KIANFAR, E., 2022. Comparison and evaluation of the performance of graphene-based biosensors. *Carbon Letters*, vol. 32, no. 4, pp. 927-951. <http://dx.doi.org/10.1007/s42823-022-00338-6>.
- ADHIKARI, B. and MAJUMDAR, S., 2004. Polymers in sensor applications. *Progress in Polymer Science*, vol. 29, no. 7, pp. 699-766. <http://dx.doi.org/10.1016/j.progpolymsci.2004.03.002>.
- AGRAWAL, A., MAJDI, J., CLOUSE, K.A. and STANTCHEV, T., 2018. Electron-beam-lithographed nanostructures as reference materials for label-free scattered-light biosensing of single filoviruses. *Sensors*, vol. 18, no. 6, p. 1670. <http://dx.doi.org/10.3390/s18061670>. PMID:29789514.
- AL SARRAF, A.A.M., ALSULTANY, F.H., MAHMOUD, Z.H., SHAFIK, S.S., AL MASHHADANI, Z.I. and SAJJADI, A., 2022. Magnetic nanoparticles supported zinc (II) complex (Fe<sub>3</sub>O<sub>4</sub>@SiO<sub>2</sub>-Imine/Thio-Zn(OAc)<sub>2</sub>): a green and efficient magnetically reusable zinc nanocatalyst for synthesis of nitriles via cyanation of aryl iodides. *Synthetic Communications*, vol. 52, pp. 1245-1253. <http://dx.doi.org/10.1080/00397911.2022.2079992>.
- ARNDT, N., TRAN, H.D.N., ZHANG, R., XU, Z.P. and TA, H.T., 2020. Different approaches to develop nanosensors for diagnosis of diseases. *Advanced Science*, vol. 7, no. 24, p. 2001476. <http://dx.doi.org/10.1002/advs.202001476>. PMID:33344116.
- BAHADORAN, A., JABARABADI, M.K., MAHMOOD, Z.H., BOKOV, D., JANANI, B.J. and FAKHRI, A., 2022. Quick and sensitive colorimetric detection of amino acid with functionalized-silver/copper nanoparticles in the presence of cross linker, and bacteria detection by using DNA-template nanoparticles as peroxidase activity. *Spectrochimica Acta. Part A: Molecular and Biomolecular Spectroscopy*, vol. 268, p. 120636. <http://dx.doi.org/10.1016/j.saa.2021.120636>. PMID:34890872.
- BANDODKAR, A.J., JEERAPAN, I. and WANG, J., 2016. Wearable chemical sensors: present challenges and future prospects. *ACS Sensors*, vol. 1, no. 5, pp. 464-482. <http://dx.doi.org/10.1021/acssensors.6b00250>.
- BOKOV, D.O., MUSTAFA, Y.F., MAHMOUD, Z.H., SUKSATAN, W., JAWAD, M.A. and XU, T., 2022. Cr-SiNT, Mn-SiNT, Ti-C<sub>70</sub> and Sc-CNT as effective catalysts for CO<sub>2</sub> reduction to CH<sub>3</sub>OH. *Silicon*, vol. 14, no. 14, pp. 8493-8503. <http://dx.doi.org/10.1007/s12633-022-01653-3>.
- BONYANI, M., MIRZAEI, A., LEONARDI, S.G. and NERI, G., 2016. Silver nanoparticles/polymethacrylic acid (AgNPs/PMA) hybrid nanocomposites-modified electrodes for the electrochemical detection of nitrate ions. *Measurement*, vol. 84, pp. 83-90. <http://dx.doi.org/10.1016/j.measurement.2016.02.005>.
- BORGOGNONI, C.F., KIM, J.H., ZUCOLOTTI, V., FUCHS, H. and RIEHEMANN, K., 2018. Human macrophage responses to metal-oxide nanoparticles: a review. *Artificial Cells, Nanomedicine, and Biotechnology*, vol. 46, suppl. 2, pp. 694-703. <http://dx.doi.org/10.1080/21691401.2018.1468767>. PMID:29726285.
- BOTT, J. and FRANZ, R., 2019. Investigations into the potential abrasive release of nanomaterials due to material stress conditions—part A: carbon black nano-particulates in plastic and rubber composites. *Applied Sciences*, vol. 9, no. 2, p. 214. <http://dx.doi.org/10.3390/app9020214>.



- CAON, T., MARTELLI, S.M. and FAKHOURI, F.M., 2017. New trends in the food industry: application of nanosensors in food packaging. In: A.M. GRUMEZESCU, ed. *Nanobiosensors*. London: Academic Press, pp. 773-804. <http://dx.doi.org/10.1016/B978-0-12-804301-1.00018-7>.
- CHEN, X., WU, G., CAI, Z., OYAMA, M. and CHEN, X., 2014. Advances in enzyme-free electrochemical sensors for hydrogen peroxide, glucose, and uric acid. *Microchimica Acta*, vol. 181, no. 7-8, pp. 689-705. <http://dx.doi.org/10.1007/s00604-013-1098-0>.
- DAHMAN, Y., 2017. *Nanotechnology and functional materials for engineers*. Amsterdam: Elsevier.
- EHGARTNER, J., STROBL, M., BOLIVAR, J.M., RABL, D., ROTHBAUER, M., ERTL, P., BORISOV, S.M. and MAYR, T., 2016. Simultaneous determination of oxygen and pH inside microfluidic devices using core-shell nanosensors. *Analytical Chemistry*, vol. 88, no. 19, pp. 9796-9804. <http://dx.doi.org/10.1021/acs.analchem.6b02849>. PMID:27610829.
- FATTAH, I.M.R., FARHAN, Z.A., KONTOLEON, K.J., KIANFAR, E. and HADRAWI, S.K., 2023. Hollow fiber membrane contactor based carbon dioxide absorption - stripping: a review. *Macromolecular Research*. In press. <http://dx.doi.org/10.1007/s13233-023-00113-0>.
- FREEMAN, M.H., HALL, J.R. and LEOPOLD, M.C., 2013. Monolayer-protected nanoparticle doped xerogels as functional components of amperometric glucose biosensors. *Analytical Chemistry*, vol. 85, no. 8, pp. 4057-4065. <http://dx.doi.org/10.1021/ac3037188>. PMID:23472762.
- FUERTES, G., SOTO, I., CARRASCO, R., VARGAS, M., SABATTIN, J. and LAGOS, C., 2016. Intelligent packaging systems: sensors and nanosensors to monitor food quality and safety. *Journal of Sensors*, vol. 2016, p. 4046061. <http://dx.doi.org/10.1155/2016/4046061>.
- GAUGLITZ, G., BRECHT, A., KRAUS, G. and MAHM, W., 1993. Chemical/biochemical sensors based on interferometry at thin (multi) layers. *Sensors and Actuators. B, Chemical*, vol. 11, no. 1-3, pp. 21-27. [http://dx.doi.org/10.1016/0925-4005\(93\)85234-2](http://dx.doi.org/10.1016/0925-4005(93)85234-2).
- GUPTA, V., HASSAN, K. and ROYA, S., 2015. Simultaneous determination of hydroxylamine, phenolsulfite in wastewater water samples using a voltammetric nanosensor. *International Journal of Electrochemical Science*, vol. 10, pp. 303-316.
- HACHEM, K., ANSARI, M.J., SALEH, R.O., KZAR, H.H., AL-GAZALLY, M.E., ALTIMARI, U.S., HUSSEIN, S.A., MOHAMMED, H.T., HAMMID, A.T. and KIANFAR, E., 2022. Methods of chemical synthesis in the synthesis of nanomaterial and nanoparticles by the chemical deposition method: a review. *BioNanoScience*, vol. 12, no. 3, pp. 1032-1057. <http://dx.doi.org/10.1007/s12668-022-00996-w>.
- HAN, W.S., LEE, H.Y., JUNG, S.H., LEE, S.J. and JUNG, J.H., 2009. Silica-based chromogenic/fluorogenic hybrid chemosensor materials. *Chemical Society Reviews*, vol. 38, no. 7, pp. 1904-1915. <http://dx.doi.org/10.1039/b818893a>. PMID:19551171.
- HISAMOTO, H. and SUZUKI, K., 1999. Ion-selective optodes: current developments and future prospects. *Trends Analytical Chemistry*, vol. 18, no. 8, pp. 513-524. [http://dx.doi.org/10.1016/S0165-9936\(99\)00137-5](http://dx.doi.org/10.1016/S0165-9936(99)00137-5).
- HOU, Y., LI, X.-Y., ZHAO, Q.-D., QUAN, X. and CHEN, G.H., 2010. Electrochemical method for synthesis of a ZnFe<sub>2</sub>O<sub>4</sub>/TiO<sub>2</sub> composite nanotube array modified electrode with enhanced photoelectrochemical activity. *Advanced Functional Materials*, vol. 20, no. 13, pp. 2165-2174. <http://dx.doi.org/10.1002/adfm.200902390>.
- HUANG, X., ZHU, Y. and KIANFAR, E., 2021. Nano biosensors: properties, applications and electrochemical techniques. *Journal of Materials Research and Technology*, vol. 12, pp. 1649-1672. <http://dx.doi.org/10.1016/j.jmrt.2021.03.048>.
- HUNTER, R.A., PRIVETT, B.J., HENLEY, W.H., BREED, E.R., LIANG, Z., MITTAL, R., YOSEPH, B.P., MCDUNN, J.E., BURD, E.M., COOPERSMITH, C.M., RAMSEY, J.M. and SCHOENFISCH, M.H., 2013. Microfluidic amperometric sensor for analysis of nitric oxide in whole blood. *Analytical Chemistry*, vol. 85, no. 12, pp. 6066-6072. <http://dx.doi.org/10.1021/ac400932s>. PMID:23692300.
- JAMES, T.D., SANDANAYAKE, K.R.A.S., IGUCHI, R. and SHINKAI, S., 1995. Novel saccharide-photoinduced electron transfer sensors based on the interaction of boronic acid and amine. *Journal of the American Chemical Society*, vol. 117, no. 35, pp. 8982-8987. <http://dx.doi.org/10.1021/ja00140a013>.
- JANATA, J. and BEZEGH, A., 1988. Chemical sensors. *Analytical Chemistry*, vol. 60, no. 12, pp. 62-74. <http://dx.doi.org/10.1021/ac00163a004>. PMID:3046430.
- JASIM, S.A., KADHIM, M.M., KN, V., RAYA, I., SHOJA, S.J., SUKSATAN, W., ALI, M.H. and KIANFAR, E., 2022. Molecular junctions: introduction and physical foundations, nanoelectrical conductivity and electronic structure and charge transfer in organic molecular junctions. *Brazilian Journal of Physics*, vol. 52, no. 2, p. 31. <http://dx.doi.org/10.1007/s13538-021-01033-z>.
- JIMENEZ-FALCAO, S., VILLALONGA, A., ARÉVALO-VILLENNA, M., BRIONES-PÉREZ, A., MARTÍNEZ-MÁÑEZ, R., MARTÍNEZ-RUIZ, P. and VILLALONGA, R., 2020. Enzyme-controlled mesoporous nanosensor for the detection of living *Saccharomyces cerevisiae*. *Sensors and Actuators. B, Chemical*, vol. 303, p. 127197. <http://dx.doi.org/10.1016/j.snb.2019.127197>.
- JUNG, J.H., LEE, J.H. and SHINKAI, S., 2011. Functionalized magnetic nanoparticles as chemosensors/adsorbents for toxic metal ions in environmental/biological fields. *Chemical Society Reviews*, vol. 40, no. 9, pp. 4464-4474. <http://dx.doi.org/10.1039/c1cs15051k>. PMID:21607241.
- KADHIM, M.M., RHEIMA, A.M., ABBAS, Z.S., JLOOD, H.H., HACHIM, S.K., KADHUM, W.R. and KIANFAR, E., 2023. Evaluation of a biosensor-based graphene oxide-DNA nanohybrid for lung cancer. *RSC Advances*, vol. 13, no. 4, pp. 2487-2500. <http://dx.doi.org/10.1039/D2RA05808A>. PMID:36741187.
- KANIUSAS, E., PFÜTZNER, H., MEHNEN, L., KOSEL, J., TÉLLEZ-BLANCO, J.C., MULSALIHVIC, E., MEYDAN, T., VÁZQUEZ, M., ROHN, M., MALVICINO, C. and MARQUARDT, B., 2004. Optimisation of sensitivity and time constant of thermal sensors based on magnetoelastic amorphous bilayers. *Journal of Alloys and Compounds*, vol. 369, no. 1-2, pp. 198-201. <http://dx.doi.org/10.1016/j.jallcom.2003.09.103>.
- KEARNS, H., GOODACRE, R., JAMIESON, L.E., GRAHAM, D. and FAULDS, K., 2017. SERS detection of multiple antimicrobial-resistant pathogens using nanosensors. *Analytical Chemistry*, vol. 89, no. 23, pp. 12666-12673. <http://dx.doi.org/10.1021/acs.analchem.7b02653>. PMID:28985467.
- KIANFAR, E., 2023. The Effects of SiO<sub>2</sub>/Al<sub>2</sub>O<sub>3</sub> and H<sub>2</sub>O/Al<sub>2</sub>O<sub>3</sub> molar ratios on SAPO-34 catalyst in the methanol to olefin process. *Silicon*, vol. 15, no. 1, pp. 381-396. <http://dx.doi.org/10.1007/s12633-022-02008-8>.
- KIM, J.S. and QUANG, D.T., 2007. Calixarene-derived fluorescent probes. *Chemical Reviews*, vol. 107, no. 9, pp. 3780-3799. <http://dx.doi.org/10.1021/cr068046j>. PMID:17711335.
- LEE, Y.J. and PARK, J.Y., 2011. A highly miniaturized dissolved oxygen sensor using a nanoporous platinum electrode electroplated on silicon. *Journal of the Korean Physical Society*, vol. 58, pp. 1505-1510. <http://dx.doi.org/10.3938/jkps.58.1505>.
- LIN, J., CAI, X., LIU, Z., LIU, N., XIE, M., ZHOU, B.P., WANG, H. and GUO, Z., 2020. Anti-liquid-interfering and bacterially antiadhesive strategy for highly stretchable and ultrasensitive strain sensors based on



- Cassie-Baxter wetting state. *Advanced Functional Materials*, vol. 30, no. 23, p. 2000398. <http://dx.doi.org/10.1002/adfm.202000398>.
- MADOU, M.J. and MORRISON, S.R., 1989. *Chemical sensing with solid state devices*. London: Academic press.
- MAHMOOD, Z.H., RIADI, Y., HAMMOODI, H.A., ALKAIM, A.F. and MUSTAFA, Y.F., 2022. Magnetic nanoparticles supported copper nanocomposite: a highly active nanocatalyst for synthesis of benzothiazoles and polyhydroquinolines. *Polycyclic Aromatic Compounds*, pp. 1-19. In press. <http://dx.doi.org/10.1080/10406638.2022.2077390>.
- MAHMOUD, Z.H., AL-BAYATI, R.A. and KHADOM, A.A., 2022a. Electron transport in dye-sanitized solar cell with tin-doped titanium dioxide as photoanode materials. *Journal of Materials Science Materials in Electronics*, vol. 33, no. 8, pp. 5009-5023. <http://dx.doi.org/10.1007/s10854-021-07690-9>.
- MAHMOUD, Z.H., AL-BAYATI, R.A. and KHADOM, A.A., 2022b. The efficacy of samarium loaded titanium dioxide (Sm: TiO<sub>2</sub>) for enhanced photocatalytic removal of rhodamine B dye in natural sunlight exposure. *Journal of Molecular Structure*, vol. 1253, p. 132267. <http://dx.doi.org/10.1016/j.molstruc.2021.132267>.
- MAHMOUD, Z.H., BARAZANDEH, H., MOSTAFAVI, S.M., ERSHOV, K., GONCHAROV, A., KUZNETSOV, A.S., KRAVCHENKO, O.D. and ZHU, Y., 2021. Identification of rejuvenation and relaxation regions in a Zr-based metallic glass induced by laser shock peening. *Journal of Materials Research and Technology*, vol. 11, pp. 2015-2020. <http://dx.doi.org/10.1016/j.jmrt.2021.02.025>.
- MAHMOUDPOUR, M., DOLATABADI, J.E.N., TORBATI, M., TAZEHKAND, A.P., HOMAYOUNI-RAD, A. and GUARDIA, M., 2019. Nanomaterials and new biorecognition molecules based surface plasmon resonance biosensors for mycotoxin detection. *Biosensors & Bioelectronics*, vol. 143, p. 111603. <http://dx.doi.org/10.1016/j.bios.2019.111603>. PMID:31445387.
- MARTÍNEZ-MÁÑEZ, R. and SANCENÓN, F., 2003. Fluorogenic and chromogenic chemosensors and reagents for anions. *Chemical Reviews*, vol. 103, no. 11, pp. 4419-4476. <http://dx.doi.org/10.1021/cr010421e>. PMID:14611267.
- MOTSENBOCKER, M., ICHIMORI, Y. and KONDO, K., 1993. Metal porphyrin chemiluminescence reaction and application to immunoassay. *Analytical Chemistry*, vol. 65, pp. 397-402. <http://dx.doi.org/10.1021/ac00052a015>.
- NTIM, S.A., NORRIS, S., GOODWIN JUNIOR, D.G., BREFFKE, J., SCOTT, K., SUNG, L., THOMAS, T.A. and NOONAN, G.O., 2018. Effects of consumer use practices on nanosilver release from commercially available food contact materials. *Food Additives & Contaminants. Part A, Chemistry, Analysis, Control, Exposure & Risk Assessment*, vol. 35, no. 11, pp. 2279-2290. <http://dx.doi.org/10.1080/19440049.2018.1529437>. PMID:30352016.
- OMER, D., MUSTAFA, Z.M., HASAN, S.M., DHAMEER, A.M., KHUSNIDDIN, F.U. and EHSAN, K., 2022. Investigation of effective parameters Ce and Zr in the synthesis of H-ZSM-5 and SAPO-34 on the production of light olefins from naphtha. *Advances in Materials Science and Engineering*, vol. 2022, p. 6165180. <http://dx.doi.org/10.1155/2022/6165180>.
- RAYA, I., WIDJAJA, G., MAHMOOD, Z.H., KADHIM, A.J., VLADIMIROVICH, K.O., MUSTAFA, Y.F., KADHIM, M.M., MAHMUDIONO, T., HUSEIN, I. and KAFI-AHMADI, L., 2022. Kinetic, isotherm, and thermodynamic studies on Cr(VI) adsorption using cellulose acetate/graphene oxide composite nanofibers. *Applied Physics. A, Materials Science & Processing*, vol. 128, no. 2, p. 167. <http://dx.doi.org/10.1007/s00339-022-05307-4>.
- SHEN, C.-L., SU, L.-X., ZANG, J.-H., LI, X.J., LOU, Q. and SHAN, C.X., 2017. Carbon nanodots as dual-mode nanosensors for selective detection of hydrogen peroxide. *Nanoscale Research Letters*, vol. 12, no. 1, p. 447. <http://dx.doi.org/10.1186/s11671-017-2214-6>. PMID:28687039.
- SMAISIM, G.F., ABED, A.M., AL-MADHHACHI, H., HADRAWI, S.K., AL-KHATEEB, H.M.M. and KIANFAR, E., 2023. Graphene-based important carbon structures and nanomaterials for energy storage applications as chemical capacitors and supercapacitor electrodes: a review. *BioNanoScience*, vol. 13, no. 1, pp. 219-248. <http://dx.doi.org/10.1007/s12668-022-01048-z>.
- SMAISIM, G.F., MOHAMMED, D.B., ABDULHADI, A.M., UKTAMOV, K.F., ALSULTANY, F.H., IZZAT, S.E., ANSARI, M.J., KZAR, H.H., AL-GAZALLY, M.E. and KIANFAR, E., 2022. Nanofluids: properties and applications. *Journal of Sol-Gel Science and Technology*, vol. 104, no. 1, pp. 1-35. <http://dx.doi.org/10.1007/s10971-022-05859-0>.
- SRIVASTAVA, A.K., DEV, A. and KARMAKAR, S., 2018. Nanosensors and nanobiosensors in food and agriculture. *Environmental Chemistry Letters*, vol. 16, no. 1, pp. 161-182. <http://dx.doi.org/10.1007/s10311-017-0674-7>.
- SUN, C., PAN, L., ZHANG, L., HUANG, J., YAO, D., WANG, C., ZHANG, Y., JIANG, N., CHEN, L. and YUAN, C., 2019. A biomimetic fluorescent nanosensor based on imprinted polymers modified with carbon dots for sensitive detection of alpha-fetoprotein in clinical samples. *Analyst*, vol. 144, no. 22, pp. 6760-6772. <http://dx.doi.org/10.1039/C9AN01065C>.
- SURYATNA, A., RAYA, I., THANGAVELU, L., ALHACHAMI, F.R., KADHIM, M.M., ALTIMARI, U.S., MAHMOUD, Z.H., MUSTAFA, Y.F. and KIANFAR, E., 2022. A review of high-energy density lithium-air battery technology: investigating the effect of oxides and nanocatalysts. *Journal of Chemistry*, vol. 2022, p. 2762647. <http://dx.doi.org/10.1155/2022/2762647>.
- TAHMASEBI, S., EL-ESAWI, M.A., MAHMOUD, Z.H., TIMOSHIN, A., VALIZADEH, H., ROSHANGAR, L., VARSHOCH, M., VAEZ, A., ASLANI, S., NAVASHENAG, J.G., AGHEBATI-MALEKI, L. and AHMADI, M., 2021. Immunomodulatory effects of nanocurcumin on Th17 cell responses in mild and severe COVID-19 patients. *Journal of Cellular Physiology*, vol. 236, no. 7, pp. 5325-5338. <http://dx.doi.org/10.1002/jcp.30233>. PMID:33372280.
- TANG, N., ZHOU, C., XU, L., JIANG, Y., QU, H. and DUAN, X., 2019. A fully integrated wireless flexible ammonia sensor fabricated by soft nano-lithography. *ACS Sensors*, vol. 4, no. 3, pp. 726-732. <http://dx.doi.org/10.1021/acssensors.8b01690>. PMID:30793588.
- TIWARI, A. and ANTHONY, P., 2014. *Biosensors nanotechnology*. Hoboken: John Wiley & Sons. <http://dx.doi.org/10.1002/9781118773826>.
- VIKESLAND, P.J., 2018. Nanosensors for water quality monitoring. *Nature Nanotechnology*, vol. 13, no. 8, pp. 651-660. <http://dx.doi.org/10.1038/s41565-018-0209-9>. PMID:30082808.
- VUNAIN, E. and MISHRA, A.K., 2018. Nanosensors as tools for water resources. In: A.K. MISHRA and C.M. HUSSAIN, eds. *Nanotechnology for sustainable water resources*. Hoboken: John Wiley & Sons, pp. 177-198. <https://doi.org/10.1002/9781119323655.ch6>.
- WANG, Y., FRY, H.C., SKINNER, G.E., SCHILL, K.M. and DUNCAN, T.V., 2017. Detection and quantification of biologically active botulinum neurotoxin serotypes A and B using a forster resonance energy transfer-based quantum dot nanobiosensor. *ACS Applied Materials & Interfaces*, vol. 9, no. 37, pp. 31446-31457. <http://dx.doi.org/10.1021/acsmi.7b08736>. PMID:28840718.
- WU, Y., SU, Y., BAI, J., ZHU, G., ZHANG, X., LI, Z., XIANG, Y. and SHI, J., 2016. A self-powered triboelectric nanosensor for PH detection. *Journal of Nanomaterials*, vol. 2016, p. 5121572. <http://dx.doi.org/10.1155/2016/5121572>.

- XIAO, X., WU, T., CAO, J., ZHU, C., LIU, Y., ZHANG, X. and SHEN, Y., 2020. Rational engineering of chromic material as near-infrared ratiometric fluorescent nanosensor for H<sub>2</sub>S monitoring in real food samples. *Sensors and Actuators. B, Chemical*, vol. 323, p. 128707. <http://dx.doi.org/10.1016/j.snb.2020.128707>.
- XU, B. and ZHANG, W.-D., 2010. Modification of vertically aligned carbon nanotubes with RuO<sub>2</sub> for a solid-state pH sensor. *Electrochimica Acta*, vol. 55, no. 8, pp. 2859-2864. <http://dx.doi.org/10.1016/j.electacta.2009.12.099>.
- XU, T., SCAFA, N., XU, L.-P., ZHOU, S., AL-GHANEM, K.A., MAHBOOB, S., FUGETSU, B. and ZHANG, X., 2016. Electrochemical hydrogen sulfide biosensors. *The Analyst*, vol. 141, no. 4, pp. 1185-1195. <http://dx.doi.org/10.1039/C5AN02208H>. PMID:26806283.
- ZHANG, H., SUN, M., SONG, L., GUO, J. and ZHANG, L., 2019. Fate of NaClO and membrane foulants during in-situ cleaning of membrane bioreactors: combined effect on thermodynamic properties of sludge. *Biochemical Engineering Journal*, vol. 147, pp. 146-152. <http://dx.doi.org/10.1016/j.bej.2019.04.016>.
- ZHANG, L., PENG, D., LIANG, R.-P. and QIU, J.-D., 2018. Graphene-based optical nanosensors for detection of heavy metal ions. *Trends in Analytical Chemistry*, vol. 102, pp. 280-289. <http://dx.doi.org/10.1016/j.trac.2018.02.010>.
- ZHUIYKOV, S., 2012. Solid-state sensors monitoring parameters of water quality for the next generation of wireless sensor networks. *Sensors and Actuators. B, Chemical*, vol. 161, no. 1, pp. 1-20. <http://dx.doi.org/10.1016/j.snb.2011.10.078>.