

THE THERMAL DECOMPOSITION OF MONOHYDRATED AMMONIUM OXOTRIS(OXALATE)NIOBATE

F. F. P. Medeiros¹, M. F. V. Moura², A. G. P da Silva³, C. P. Souza¹,
K. K. P. Gomes¹ and U. U. Gomes²

^{1,2}Universidade Federal Rio Grande do Norte, CT, DEQ¹ / CCET/DFTE², Campus Universitário,
Phone: +(55) (84) 3215-3769/Fax: 3215-3770, CEP 59072-970, Natal - RN, Brazil.
E-mail: carlson@ufrnet.br

³Universidade Estadual do Norte Fluminense, LAMAV,
CEP: 28015-620, Campos - RJ, Brazil.

(Received: February 13, 2003 ; Accepted: July 17, 2006)

Abstract - The thermal decomposition in argon of the monohydrated ammonium tris(oxalate)niobate, $(\text{NH}_4)_3\text{NbO}(\text{C}_2\text{O}_4)_3 \cdot \text{H}_2\text{O}$, has been studied by TG/DTG, DTA, DSC, IR absorption and XRD. The material decomposes stepwise by the release of CO , CO_2 , NH_3 and water. The atomic structure of the complex initially becomes amorphous and then crystallizes twice in the form of orthorhombic and monoclinic niobium pentoxide.

Keywords: Thermal decomposition; Thermal analysis; Infrared; Niobium complex.

INTRODUCTION

The oxalate ion is a bidentate, chelate ligand that can form complexes with niobium (Cotton and Wilkinson, 1982). The niobium complexes are named according to the number of oxalate groups that bonds to the niobium ion. These complexes can be obtained with the dissolution of hydrated niobium oxide in an aqueous oxalic acid solution, followed by a treatment with a suitable salt. The first niobium complexes were obtained from the alkali metals and were named mono, bis and tris(oxalate) niobate (Khrishnamurthy and Harris, 1961).

Mathern et al. (1969), determined the structure of monohydrated ammonium oxotris(oxalate) niobate. Its formula is $(\text{NH}_4)_3\text{NbO}(\text{C}_2\text{O}_4)_3 \cdot \text{H}_2\text{O}$. Niobium is seven coordinated (to three oxalate groups and to oxygen), forming a pentagonal bipyramid.

Monohydrated ammonium oxotris(oxalate)niobate and monohydrated ammonium oxotris(oxalate)tantalate

have been used for synthesizing NbC and TaC, respectively, at low temperatures (between 950°C and 1050°C) through a gas-solid reaction (Medeiros et al., 2002; Ciaravino et al., 2002). The gaseous reactant is a mixture of CH_4 and H_2 . Methane is the carbon source. Hydrogen avoids the precipitation of free carbon caused by the cracking of CH_4 (Clar, 1964) and acts as a reducer. The solid reactant is the Nb or Ta complex. The cracks and pores that appear during the thermal decomposition of the complexes increase its specific surface area and its reactivity (Medeiros et al., 2002). The conventional method utilized for producing these carbides uses temperatures as high as 1800°C (Toth, 1971; Storms, 1971).

In the present paper, the thermal decomposition of monohydrated ammonium oxotris(oxalate)niobate that is studied. Its composition is determined. The gases released and the crystalline changes that occur during the process are reported.

EXPERIMENTAL

Synthesis of the Complex

Niobium pentoxide (Nb_2O_5) is mixed with sodium hydrogen sulfate (KHSO_4) at a 1:7 weight ratio. The mixture is heated to melting in a platinum crucible. After cooling, the material is crushed and washed in a 1:1 HCl aqueous solution during 24 hours to remove impurities. Subsequently, the material is filtered and washed with hot water. Hydrated niobium oxide is formed. This oxide is added to a solution of oxalic acid and ammonium oxalate (1:1 molar ratio) and the solution is slowly evaporated. The complex precipitates and is dried at 70°C for 24 hours. The granulated material is further powdered in a mortar.

Decomposition Study

The thermal decomposition was studied by means of a combination of techniques described as follows:

- Thermogravimetry (TG/DTG) (Shimadzu TGA-50 thermobalance) in an argon atmosphere. Two temperature programs were used. In the first case, the temperature rises continuously from room temperature (RT) to 900°C at a rate of $5^\circ\text{C}/\text{min}$. In the second case, the temperature range is RT – 630°C , the heating rate is $5^\circ\text{C}/\text{min}$. and there are isotherms of 20 minutes at 140° , 200° , 250° and 620°C .

- Differential thermal analysis (DTA) (Netzsch STA 409C) in argon in the temperature range RT – 950°C and at a heating rate of $5^\circ\text{C}/\text{min}$.
- Differential scanning calorimetry (DSC) (DSC-50 Shimadzu) in argon in the temperature range RT – 600°C and at a heating rate of $2^\circ\text{C}/\text{min}$.
- C, N and H quantitative elemental analysis of the niobium complex (Perkin Elmer CHN 2400).
- X-Ray diffraction (XRD) (Siemens diffractometer, $\text{Cu K}\alpha$ radiation) of Nb_2O_5 , the niobium complex and the residue of the niobium complex decomposed at 200° , 400° , 700° and 950°C .
- Infrared spectroscopy (Perkin Elmer FTIR 16PC) using KBr tablets of Nb_2O_5 , the niobium complex and its residue after decomposition at 140° , 200° , 250° , 400° , 630° , 700° and 950°C .
- Detection of NH_3 and CO_2 released during decomposition by traps installed according to Fig. 1.

RESULTS AND DISCUSSION

Thermal Analysis

Figures 2-5 show the results of TG/DTG, DTA and DSC of the decomposing niobium complex. The TG/DTG curves (Figs 2-3) show four temperature range in which the sample loses mass. The DTA and DSC curves (Figs. 4-5) show that each mass loss event corresponds to a peak of DTA and DSC. Table 1 summarizes the results shown in Figs. 2-5.

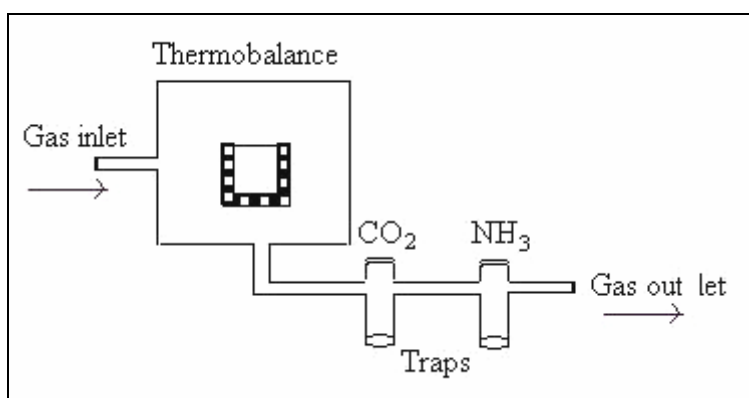

Figure 1: Outline of the apparatus utilized to detect CO_2 and NH_3 that released during the thermal decomposition.

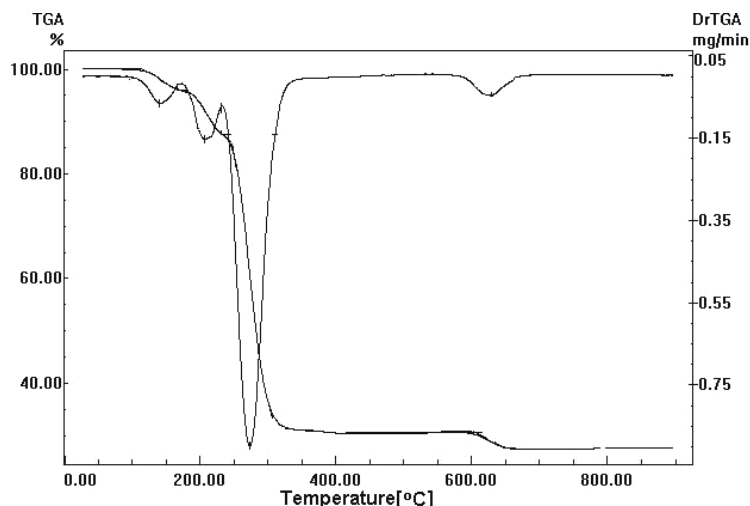

Figure 2: TG/DTG curves of the thermal decomposition in argon of the niobium complex. Heating rate: 5°C/min.

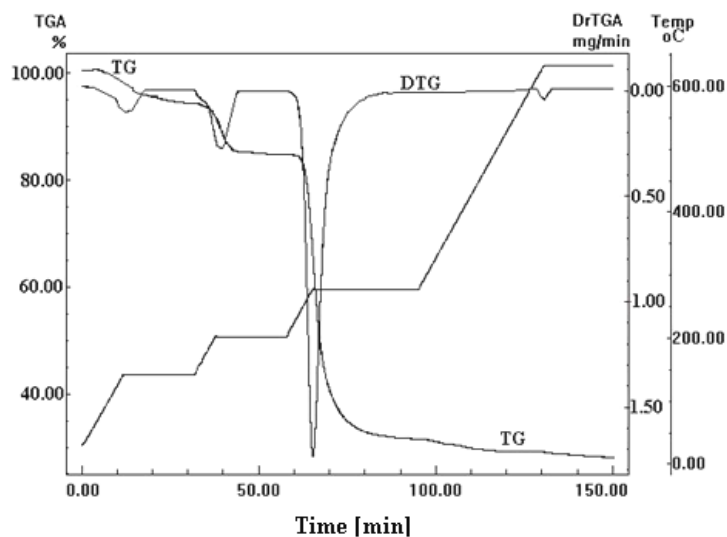

Figure 3: TG/DTG curves of the thermal decomposition in argon of the niobium complex. Temperature increases stepwise.

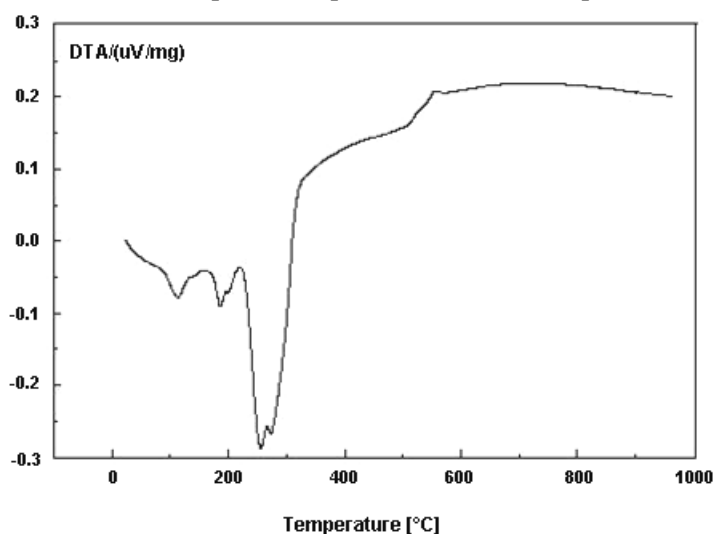

Figure 4: DTA curve of the thermal decomposition in argon of the niobium complex. Heating rate 5°C/min.

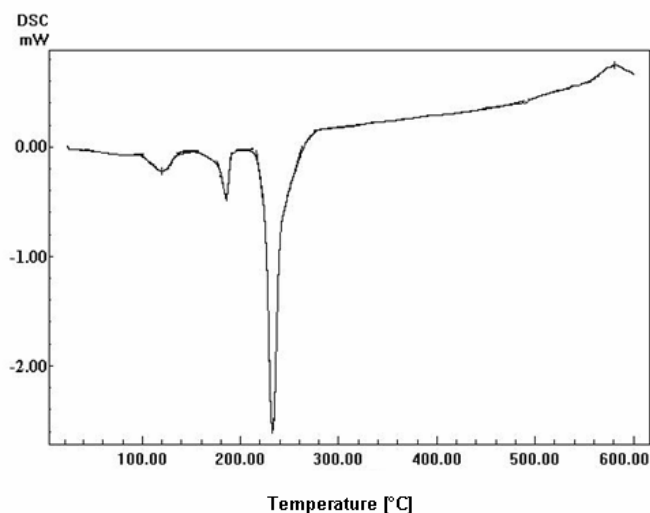

Figure 5: DSC curve of the thermal decomposition in argon of the niobium complex. Heating rate: 2°C/min.

Table 1: Summary of the TG/DTG, DTA and DSC techniques for the decomposition of the niobium complex.

Technique	Characteristics of the Event	Decomposition Step			
		1	2	3	4
TG/DTG	Initial Temperature	98°C	181°C	244°C	600°C
	Final Temperature	145°C	223°C	301°C	630°C
	Temperature of Max. Intensity	135°C	207°C	261°C	617°C
	Mass Variation %	4.3	8.4	57.30	3.02
DTA	Characteristic of the Peak	endo	endo	endo	exo
DSC	Initial Temperature	98°C	172°C	217°C	533°C
	Final Temperature	137°C	191°C	268°C	600°C
	Temperature of Max. Intensity	120°C	186°C	233°C	580°C
	Variation Enthalpy in (KJ/mol)	42.02	47.70	18.15	--

Release of Gas Phase

The releasing of both CO₂ and NH₃ was detected by the traps in the temperature intervals corresponding to the second and third mass loss events (Table 1), related to endothermic peaks on the DTA curve. Production of CO₂ is also detected around 600°C, corresponding to the fourth event (an exothermic DTA peak). Marta et al. (1983) related the releasing of this gas to the desorption of some of the CO₂ produced at a lower temperature and adsorbed on the surface of the material. But

desorption events are endothermic. Other possibilities for this CO₂ release are: (1) the oxidation of pyrolytically formed carbon by traces of oxygen in the atmosphere and (2) an event related to the decomposition of the niobium complex.

Figure 6 shows the IR spectra of the niobium complex and its residues after decomposition at several temperatures. The spectrum of the initial Nb₂O₅ is also shown. Table 2 summarizes the results and relates the absorption bands to the vibration types.

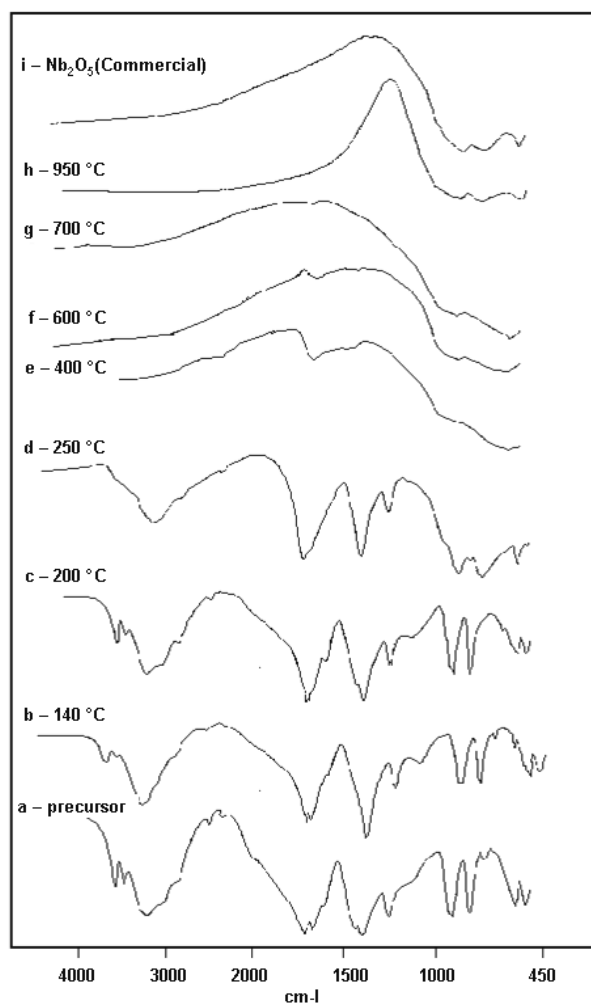

Figure 6: IR absorption spectra of the niobium complex (precursor), the complex decomposed at 140°, 200°, 250°, 400°, 600°, 700° and 950°C and the niobium oxide used as raw material.

Table 2: Absorption bands of the niobium complex and its residue after decomposition at several temperatures. The types of vibration related to the respective bands are shown.

Decomposition Temperature	Niobium complex	140°C	200°C	250°C	400°C	630°C	700°C	950°C
Type of Vibration	Absorption Bands (cm ⁻¹)							
N-H	3539	3539	3538	--	--	--	--	--
	3442	3442	3442					
H-O	3212	3212	3199	3126	--	--	--	--
v (C=O)	1714	1714	1711					
	1683	1683	1683	1722	1621	1621	--	--
v (C=O), v (C-C)	1387	1387	1389	1396	--	--	--	--
v (C-O), δ (O-C=C)	1241	1241	1239	1243	--	--	--	--
v (Nb=O)	889	889	886	--	--	--	--	--
δ (O-C=O)	793	793	790	720	--	--	--	--
v (C-C), δ (O-C=O)	538	538	534	--	--	--	--	--
δ (O-C=O) +, v (Nb-O)	479	479	479	479	--	--	--	--
v (Nb-O)	--	--	--	--	540	540	540	826
							807	691
								499

It can be seen that the absorption band related to N-H is detected only in residues decomposed up to 200°C. This corresponds to the release of the oxalate ions contained in the complex through the releasing of NH₃ up to 250°C. The absorption band related to the hydration water (H-O vibration) is not detected in the residue after decomposition at 400°C. The spectra in Fig. 6 shows that the absorption bands related to the hydration water change significantly above 200°C and vanishes in the residue of decomposition at 400°. This means that the water is released mainly in the third mass loss event, in the range from 240° to 300°C.

The absorption bands corresponding to the vibrations C=O, C=C, C-C, O-C=C and O-C=O are related to the oxalate ion. Some other bands are related to the bond between this ion and the niobium atom (Mathern et al., 1969) (Marta et al., 1983; 1979). Most of these bands are not present in the residues of decomposition above 250°C. Combining the results of the IR spectra, TG/DTG and those of the detection of released gases, one concludes that the niobium complex releases the oxalate ions stepwise in the range from 170° to 300°C. CO₂ and CO are released. Although only CO₂ was detected (CO was not analyzed), the evolution of CO and CO₂ is common in the decomposition of oxalates.

Concerning the evolution of CO₂ at around 630°C, corresponding to the fourth mass loss event detected by the TG/DTG analysis, the IR spectra of the niobium complex that decomposed at 400° and 600°C show a band corresponding to a C=O bond, but a band related to the bond between the oxalate ion and Nb was not detected. This means that the C=O bond is not related to the bond between Nb and the oxalate ion. This result definitively shows that releasing of CO₂ at 630°C is not related to the decomposition of the material.

Crystal Structure

Figure 7 shows the XRD graphs of the niobium complex, its residues after decomposition at several

temperatures and the niobium oxide used as raw material. Negligible differences are seen in the patterns of the niobium complex and its residue after decomposition at 200°C, but the complex that decomposed at 400°C is amorphous, as indicated by the diffraction pattern. The release of CO₂ and NH₃ that occurred in the second mass loss step (180°-220°C) does not disturb the crystal structure of the niobium complex, but the massive release of NH₃, CO₂ and the hydration water does transform the material into amorphous solids.

The exothermic peak at 600°C in the DTA analysis could be related to crystallization of the material and not to the release of CO₂ as mentioned previous. The residue of the niobium complex decomposed at 700°C is crystalline, corresponding to an orthorhombic structure of Nb₂O₅ (JCPDS card No. 30-0873). This crystallization process could occur or start at 600°C. The orthorhombic structure is transformed into amonoclinic structure between 700° and 950°C because the residue of the decomposition at 950°C has another crystal structure (JCPDS card No. 37-1468). This is the same structure as that of the Nb₂O₅ used as raw material, but it is not as well crystallized.

Elemental Analysis

Nitrogen, hydrogen and carbon in the niobium complex were quantitatively analyzed. Niobium was indirectly analyzed. The residual mass of the niobium complex after calcination in air at a high temperature was measured and the Nb content was calculated, considering that the calcination product is Nb₂O₅. The water content is determined by the mass balance. The results are shown in Table 3, together with a simulation in which the niobium complex formula is assumed to be (NH₄)₃NbO(C₂O₄)₃·H₂O. The results of the measurements and the simulation are in good agreement.

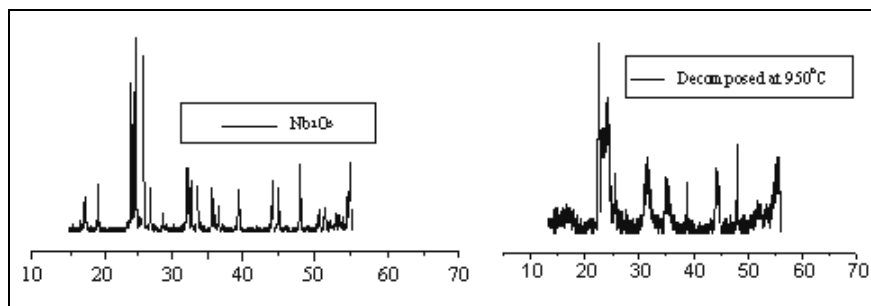

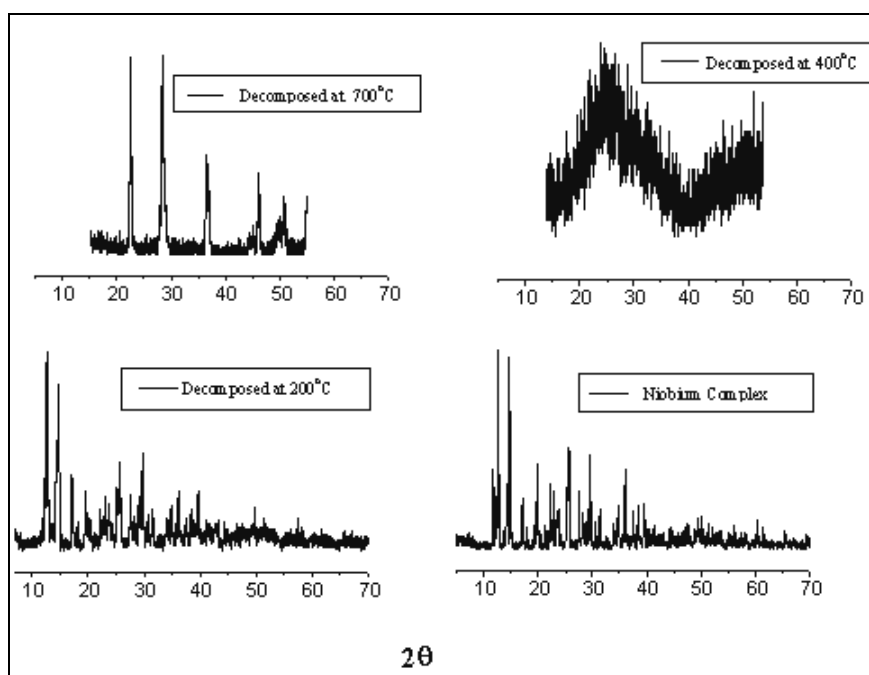

Figure 7: XRD patterns of the niobium complex (precursor), the complex decomposed at 200°, 400°, 700° and 950°C and the niobium oxide used as raw material.

Table 3: Quantitative analysis of Nb, C, N, H and H₂O in the niobium complex and simulation based on the formula (NH₄)₃NbO(C₂O₄)₃·H₂O.

Quantities (weight %)	Nb	C	N	H	H ₂ O
Measurement	19.4	16.2	9.4	3.2	4.0
Simulation	19.3	16.6	9.7	3.2	4.0

CONCLUSIONS

During heating, the complex monohydrated ammonium oxotris(oxalate)niobate [(NH₄)₃NbO(C₂O₄)₃·H₂O] decomposes, releasing stepwise the oxalate ions, NH₄⁺ and the hydration water in the form of CO₂ and CO, NH₃ and water vapor. Transformations also occur in the atomic structure of the material.

From 98° to 145°C, the humidity evaporates. In the range from 180° to 220°C, there is releasing of NH₃ and CO₂, corresponding to the partial release of the NH₄⁺ and oxalate ions. The crystal structure of the niobium complex is not altered up to this temperature. Between 240° and 300°C, there is an intense loss of mass, corresponding to the evolution of NH₃, CO₂, CO and the hydration water. The crystal structure collapses and becomes amorphous. All NH₄⁺ ions and the hydration water are released.

At around 600°, there is an evolution of the residual carbon in the form of CO₂. In the same temperature

range, the material crystallizes as orthorhombic Nb₂O₅. At higher temperatures, but below 950°C, the structure is transformed into the monoclinic Nb₂O₅.

ACKNOWLEDGEMENTS

We are grateful to CNPq.

REFERENCES

- Ciaravino, C., Medeiros, F.F.P., Souza, C.P., Satre, P. and Roubin, M., Elaboration of Mixed Tantalum and Niobium Carbides from Tantalite Mineral. *J. of Materials Science*. 37(10), pp.2117-2123 (2002).
- Clar, E., Ph. D. Diss., Obtention et propriétés de carbures métalliques simples et mixtes à grain fin, Faculté des Sciences de L'Université de Lyon Université Lyon, France (1964).

- Cotton, F.A. and Wilkinson, G., Química Inorgânica, LTC, São Paulo, p.118 (1982).
- Krishnamurty, K.V. and Harris, G.M., The Chemistry of Metal Oxalates Complexes. Chem. Rev, 61, 3, pp. 213-246 (1961).
- Marta, L., Zaharescu, M. and Macarovici, C.G., Thermal and Structural Investigation of Some Oxalates-Niobium Complexes 3. Strontium Tris(oxalate)oxoniobate. J. Thermal Analysis, 26, p. 87 (1983).
- Marta, L., Zaharescu, M. and Macarovici, C.G., Thermal and Structural Investigation of Some Oxalate-niobium Complexes, Potassium Tris(oxalate)oxoniobate. Revue Roumaine de Chimie, 24, 8, p.1115 (1979).
- Mathern, G., Weiss R. and Rohmer, R., The Crystal Structures of Ammonium Oxotrioxalatonibate Monohydrate and Ammonium Diperoxodioxalatonibate Monohydrate. Chem. Comm., 70 (1969).
- Medeiros, F.F.P., Silva, A.G.P. and Souza, C.P., Synthesis of Niobium Carbide at Low Temperature and Its Use in Hardmetal. Powder Technology 126, pp. 155-160 (2002).
- Storms, E.K., Refractory Carbides – A Series of Monographs. Vol. II, Academic Press, New York and London, p. 61, 82 (1971).
- Toth, L.E., Transition Carbides and Nitrides – A Series of Monographs. Vol. II, Academic Press New York and London, p. 14 (1971).