

Use of Gravity Separation in Metals Concentration from Printed Circuit Board Scraps

Uso de Separação Gravimétrica na Concentração de Metais Provenientes de Sucatas de Placas de Circuito Impresso.

Hugo Marcelo Veit

Universidade Federal do Rio Grande do Sul
Professor do Departamento de Engenharia de Materiais
hugo.veit@ufrgs.br

Nichele Cristina de Freitas Juchneski

Universidade Federal do Rio Grande do Sul
Mestranda do Programa de Pós Graduação em Engenharia de Minas, Metalúrgica e Materiais - PPGE3M
ni.juchneski@gmail.com

Janine Scherer

Universidade Federal do Rio Grande do Sul
Graduanda em Engenharia Química
janinescherer@gmail.com

Abstract

The amount of solid waste generated by all segments of society has increased in past decades. Annually, in Brazil, 96,000 tonnes of electronic scrap are generated from computers.

The incorrect disposal of this waste creates environmental damage, generating loss of materials that could be reused and / or recycled, reducing the extraction of recyclable materials to produce new materials.

The printed circuit boards (PCB) represent approximately 30% of the electronic waste generated and its recycling is a complex process, but very important for the recovery of metals of high economic value. Industrial processes for the recovery of metals from PCB are based on pyrometallurgy and hydrometallurgy. In both cases, it is possible to carry out a pretreatment that involves the use of mechanical processes.

Therefore, for this paper, the concentration of the metallic fraction of PCB through the use of a Mozley concentrator was enabled. The results show that it is possible to obtain significant quantities of metals such as copper (concentration 85%), tin (95%), and silver (98%) in the fractions of interest.

Keywords: *Electronic scrap, metals, gravity separation, printed circuit boards scrap*

Resumo

A quantidade de resíduos sólidos gerados por todos os segmentos da sociedade tem aumentado nas últimas décadas. Anualmente, no Brasil, são gerados 96 mil toneladas de sucata eletrônica proveniente de computadores.

O descarte incorreto desses resíduos gera danos ao meio ambiente, bem como perda de materiais que poderiam ser reaproveitados e/ou reciclados, diminuindo, assim a extração de matérias-primas para a produção de novos materiais.

As placas de circuito impresso (PCI) correspondem a, aproximadamente, 30% da sucata eletrônica gerada. Cabe ressaltar que realizar a reciclagem dessa sucata é um processo complexo, porém de extrema importância para a recuperação de metais de grande valor econômico. Os processos industriais, para a recuperação de metais provenientes de PCI, são baseados, em pirometalurgia e hidrometalurgia. Em ambos os processos, é possível fazer um pré-tratamento, que consiste no uso de processos mecânicos.

Desta forma, nesse trabalho, foi realizada a concentração da fração metálica das PCI através do uso de um concentrador Mozley. Os resultados mostram que é possível obter quantidades significativas de metais como cobre (concentração de 85%), estanho (95%) e prata (98%) nas frações de interesse.

Palavras-chave: *Resíduos eletroeletrônicos, metais, concentração gravimétrica, sucata de placas de circuito Impresso.*

1. Introduction

The amount of solid waste, of all types, and generated by all segments of society, has increased greatly in recent decades in Brazil, as well as in the rest of the world. One way to manage this problem is through the creation of laws and regulations to define the responsibilities for the collection, treatment, and disposal of waste.

In Brazil, the National Policy on Solid Waste (PNRS) was established in August 2010. Among the objectives of this law are the nongeneration, reduction, reuse, recycling, and treatment of solid waste in an environmentally correct manner to bring about the reduction of the volume and hazardous nature of solid waste (PNRS, 2010).

Among the types of waste materials covered by this law are electronics whose generated volume has increased above average when compared with other types of solid waste. In 2011, in Brazil, 15.4 million computers were sold, 55% of them portable equipment, such as laptops and netbooks, and 45% desktops, which consolidated the country's third position in the world market. In the first half of the same year, 7.4 million computers were sold, while in the first half of 2012, this number was 7.8 million, although the growth is 2% below the forecast of 7% (IDC^a, 2012; IDC^b, 2012).

According to studies by the United Nations (Schuluep, 2009), 96,000 tons of electronic waste from computers are generated annually, which makes Brazil the largest generator of electronic waste among the emerging countries. Still, in accordance with Bandini (2009), it is estimated that only 1.92 thousand tons of the scrap generated are recycled in the country, that is, more than 94,000 tons have an unknown end of life and this is often inappropriate and can cause contamination of the soil and water due to the presence of toxic materials.

Besides the environmental issue, the incorrect disposal of this waste represents a very significant loss of materials, as these metallic materials, polymers, ceramics, and composites could be reused and / or recycled substantially, reducing the extraction of raw materials to produce new materials.

Among the components of electronic waste, we can highlight printed circuit boards (PCB). The PCBs account

for approximately 30% of the electronic waste generated. Nonmetallic fractions such as epoxy, fiberglass, and other materials correspond to 70% of the mass of PCB and metals such as copper, tin, lead, iron, nickel, silver, and gold correspond to the remaining 30% (Murugan, 2008; Veit, 2005)

Recycling of PCB is a complex process due to its heterogeneous constitution, but is of extreme importance for the recovery of metals of high economic value. Most of these metals (copper, nickel, gold, silver, and platinum) are found in natural raw materials at very low levels, that is, obtaining them after mining involves significant environmental impacts and associated high production costs.

In contrast, secondary metal production has environmental impacts and economic costs far lower than primary production, as can be seen when comparing the material intensity (MIT) of some metals. Palladium has a primary MIT of 99,891, which means that 99,891 tons of materials are required to produce one gram of palladium, while the secondary MIT production is 2,394. Primary copper has an MIT equal to 348.47 and secondary copper has an MIT of 2.38 (Wuppertal Institute, 2011).

In 2006, 12% of the primary production of gold, 30% of the primary production of silver, and 15% of the primary production of palladium were used in the manufacture of electrical and electronic equipment (EEE) (Hagelüken, 2008). Therefore, it is observed that PCBs have high-value metals and require many resources obtained from primary processes, which justifies the recycling of these materials.

The industrial processes for the recovery of metals from PCB are based on pyrometallurgy and hydrometallurgy.

The hydrometallurgical process, when compared with the pyrometallurgical process, is more accurate, more predictable, and more easily controlled (CUI^b, 2008). The main steps in this process consist of a series of acid or alkaline leaching of the solid material. The solutions are then subjected to separation and purification processes. The disadvantages of this process vary according to the leaching used, such as high toxicity, high reagent consumption, or high costs. Furthermore, inherent in

hydrometallurgical processes is the unavoidable generation of effluents.

The pyrometallurgical process associated with electronic waste is a technology used in the recovery of nonferrous and precious metals. The typical pyrometallurgical process is the production of a copper alloy with precious metals. This technique can be considered potentially suitable for the treatment of waste electronic equipment (WEEE), where the organic compounds can be used as fuel and oxidizing agents. However, a considerable use of energy is needed and this is a process that involves high costs. The halogenated flame retardants used in the polymeric fraction of PCB favor the formation of dioxins and furans, besides the existence of volatile metals and dust that can cause environmental problems (Tuncuk, 2012).

However, in both cases, it is possible carry out pretreatment in order to increase the efficiency and lower the cost of pyrometallurgy and hydrometallurgy. This pretreatment consists usually in the disassembly, grinding, and use of mechanical processes for the separation and concentration of materials of interest. The use of mechanical processes is an alternative to the concentration of valuable metals; however, their use in recycling WEEE is not yet fully developed. For best results, the electronic scrap is to be comminuted to small fractions generally below 10 mm. The particle size, shape, and degree of release are characteristics of paramount importance to the use of mechanical processes (Cui^a, 2003).

Among the mechanical processes for separating materials of different characteristics (magnetic, electrical conductivity, and density), one can cite the concentrator tables, originally used in the concentration of coal and ores. This equipment has as principle the separation of materials by density difference. Concentrating tables, due to their characteristics, require large amounts of material for perfect operation, which is not always possible in studies on a laboratory scale. One way to study the best parameters to be used with electronic waste, in the concentrating tables, is to use a Mozley concentrator. This equipment, even on a laboratory scale, allows working with smaller amounts of sample (50 to 100g), enabling studies of separation of materials by differences in density

(Sampaio, 2005).

The Mozley concentrator is considered to be the more precise concentration equipment in water film. The equipment

consists of a flat tray for separating fine particles (10 to 100 μ m), and a separation V-shaped tray, with a 165 degree angle; it is used for coarse particles (100 μ m to

2mm) as shown in Figure 1. The parameters that can be varied beyond the tray type are tilt-tray, oscillation frequency, time and flow rate of water.

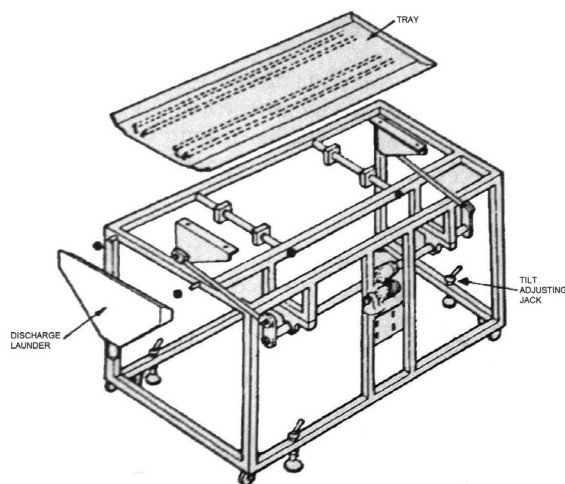

The operation of the Mozley concentrator consists of placing the sample on top of the tray, which will oscillate by a time determinate with a water flow. The oscillatory movement will cause the

lighter particles to move in the direction of the discharge launder and heavier particles concentrate at the top of the tray.

Thus, the objective of this paper was to realize the separation of the

Figure 1
Mozley Concentrator (Adapted from Sampaio, 2005)

metallic and non-metallic fractions from PCB through use of the Mozley concentrator, which simulates the performance of concentrating tables with small samples.

Materials and methods:

In this work, generic PCB from various types of equipment collected in a multi-brand service center was used. To perform the concentration of materials in different fractions by

mechanical processing, the PCBs were comminuted, and in sequence, assays were performed using dense medium separation and Mozley concentrator separation.

The printed circuit boards were comminuted in two different ways: a hammer mill for rough grinding (grid = 15mm) and one knife mill to obtain fine particles (grid = 2; 1; 0,5 e 0,25 mm).

Dense Medium Separation:

In this step, assays were performed on a sink-float to define the degree of release and the particle size to be subsequently used in the Mozley concentrator.

The tests were performed in a dense medium with 95% tetrabromoethane and

5% acetone with a density of 2.88g/cm³. The particle sizes used in the assay were: -2 +1mm, -1+0.25mm, -0.5+0.25mm, and -0.25 mm. The assays were performed at ambient temperature, with a duration of 0.5 h and a solid:liquid ratio of 1:10. The fractions

were leached with aqua regia (nitro-muriatic acid) at 60°C for 2 h with a solid:liquid ratio of 1:20. An analysis by induced coupled plasma atomic emission spectrometry (ICP-AES) was used to determine which metals were present in the fractions of “float” and “sink.”

Separation in the Mozley concentrator:

After determination of the best separation efficiency as a function of the particle size in the dense medium assay, assays were performed in the Mozley with particle size of between -1+0.25mm. The

variables evaluated in this study were the flow of water, tilt-tray, and the number of steps. Each assay was performed with 75g of the sample, previously weighed. After the assays, the fractions were dried in ovens

at 40°C for two days, then weighed and leached with aqua regia (nitro-muriatic acid) at 60°C for 2 h with a solid:liquid ratio of 1:20. The solutions obtained were analyzed by flame atomic absorption.

Results and discussion

Dense Medium Separation:

As can be seen in Figure 2, the particle size -2 +1 mm has a content of only 10% of non-metallic material in the sunk fraction, i.e. there is a high metal content of this fraction. However, as shown in

Figure 3, from total fraction of metals present in the sample about 50% of the metals were concentrated in the fraction of sunk, it results in a high loss of metals.

The fraction with the best separation

was -0.25 mm; however, to reach this particle size, much loss of material occurs during the milling process. Thus, the following were chosen for use a particle size -1 +0.25 mm where there are fewer losses

associated with the milling process and the recovery of over 80% fraction of the metal, as can be seen in Figure 3

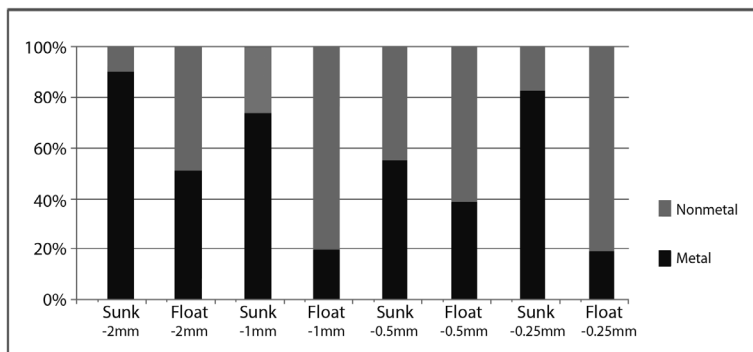

Figure 2
Metals Distribution in the Dense Medium Assay

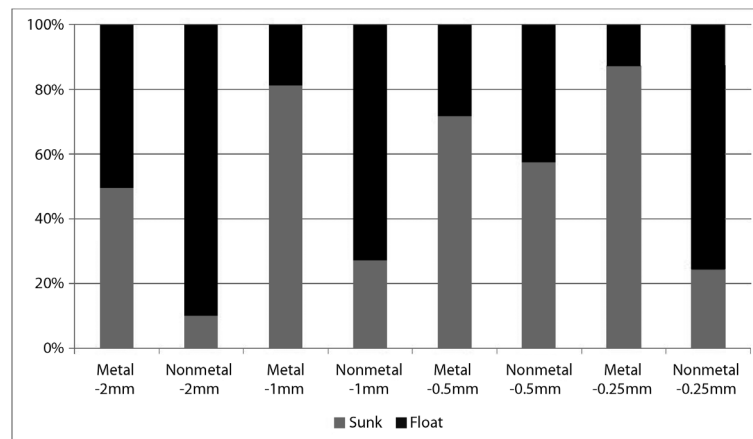

Figure 3
Metals Distribution in Sunk and Float Fractions

With the objective of verifying which metals were in the sunken and float fractions, the fractions were

leached in aqua regia (nitro-muratic acid) and analyzed by ICP-AES. Figure 4 shows the distribution of the met-

als of -1 +0.25 mm particle size, since this was chosen for use in the Mozley concentrator.

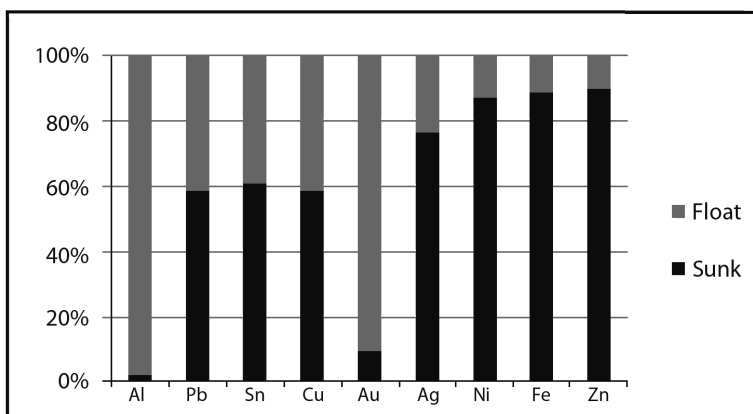

Figure 4
Metals Distribution in the Dense Medium Assay of Particle Size -1 +0.25 mm

From Figure 4, it can be seen that there was a separation of metals in the dense medium assay, where the aluminum, which has a density of 2.7 g/cm³, was concentrated

in the float fraction and other metals were concentrated in the sunken fraction, with contents above 50%. In PCBs, the gold is usually in lamellar form, hindering metal

sinking, even though it has a higher density than the fluid (Zhang, 1997), which causes it to become concentrated in the float fraction, as shown in Figure 4.

Separation in the Mozley concentrator:

For tests in the Mozley concentrator, the -1 +0.25 mm particle size was chosen for use since particle sizes smaller than 0.25 mm can interfere with the efficiency of the process (Sampaio, 2005), in addition to the problems mentioned earlier, such as the loss of materials in the

grinding step.

The fractions obtained in the Mozley concentrator were divided as concentrate, mixed, and light fractions. The concentrate get stuck to the table, being rich in metals, while the mixed fractions were composed of metals and nonmetals and

the light fractions were mainly composed of nonmetals.

As it can be seen in Figure 5, it is concluded that the first test performed in triplicates (samples 1 = A1, 2 = A2, and 3 = A3) gave the expected results, since the concentrated fraction is rich in metals

and the light fraction is rich in nonmetals. These tests were performed with a water

flow of 0.4 L/min and tilt-tray 0°.

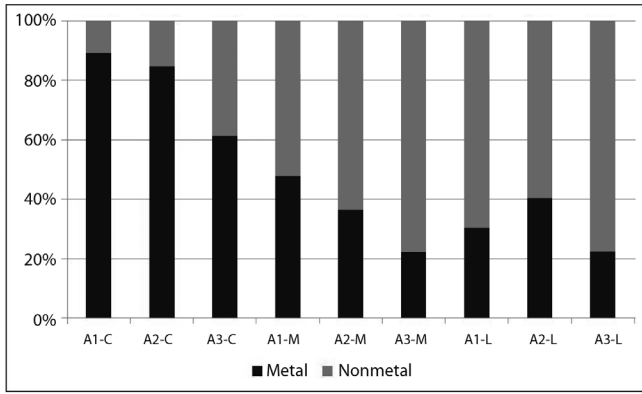

Figure 5 Preliminary Assays in the Mozley Concentrator, where A is sample, C = Concentrate, M = Mixed, and L = Light..

However, according to Figure 5, it is observed that there are still significant amounts of metals in the mixed and light fractions. Therefore, a new assay was conducted with the sample No. 4, where the

mixed and light fractions were returned to the Mozley concentrator for a new separation, yielding seven fractions, as shown in the flowchart of Figure 6. In this assay, a water flow of 0.4 L/min and tilt-tray 0.26°

was used in order to obtain a better separation between the materials. The tilt-tray was increased in order to let the light fraction have less time in contact with the table. Figure 7 and Table 1 show the results obtained.

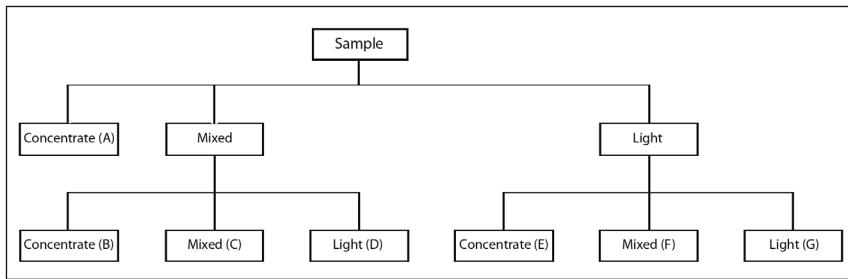

Figure 6 Flowchart of the Assay with sample 4 in the Mozley Concentrator

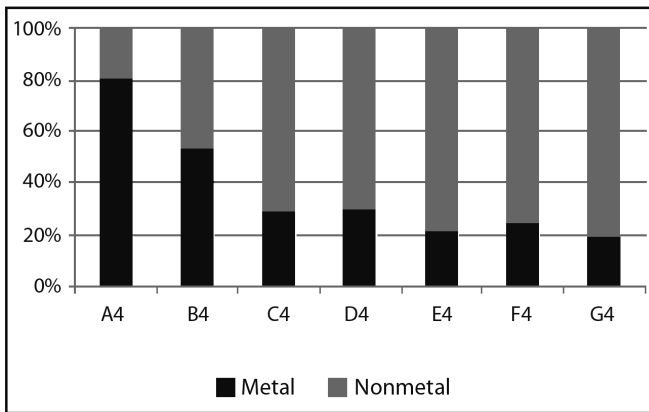

Figure 7 Results of analysis of the content of metals and nonmetals in Assay in Mozley concentrator of sample 4

Fraction	Al (%)	Pb (%)	Cu (%)	Sn (%)	Fe (%)	Ni (%)	Au (%)	Ag (%)	Zn (%)
A4	1.92	13.5	30.9	33.8	51.6	32.1	6.99	44.9	67.5
B4	12.4	11.8	23.4	46.7	23.3	16.3	13.0	24.8	20.1
C4	14.8	65.3	8.24	5.80	9.93	41.14	7.06	11.83	4.90
D4	17.3	6.22	12.7	4.30	8.60	6.64	13.1	9.72	4.90
E4	13.9	1.26	7.02	2.27	2.81	1.24	12.0	2.25	0.94
F4	19.3	1.42	10.1	3.76	2.23	1.35	22.7	3.07	0.87
G4	20.3	0.46	7.63	3.41	1.49	1.27	25.1	3.52	0.71

Table1 Metal Distribution of sample 4 in each of the Fractions.

Observing Figure 7 and Table 1, it can be concluded that most metals were concentrated in the concentrate (A4) and mixed (B4, C4, and D4) fractions. Thus, it was concluded that a new separation of the light fraction into three new fractions

(E4, F4, and G4) would be of no interest, since the objective was to obtain the largest possible amount of metals with the smallest number of steps, as the flowchart in Figure 6 proved. The gold was mainly in fractions E4, F4, and G4 due to their

lamellar form.

Based on these results, a new flowchart was proposed, as shown in Figure 8.

With this flowchart, three new assays were performed (samples 5, 6, and 7), the tests on samples 5 and 6 were

performed with water flow of 0.4 L/min and tilt-tray 0.5° and 0.26°, respectively.

The assay with sample 7 was performed with a water flow of 0.8 L/min and 0.26°

of tilt-tray. The results are shown in Tables 2 and 3.

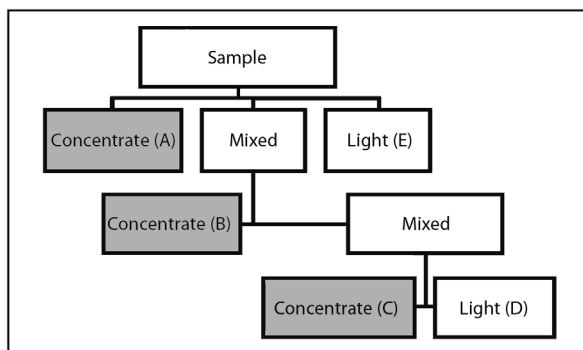

Figure 8
Flowchart used in assays of samples 5, 6, and 7.

Sample 5			Sample 6			Sample 7		
Fraction	Metal	Nonmetal	Fraction	Metal	Nonmetal	Fraction	Metal	Nonmetal
A5	77%	23%	A6	76%	24%	A7	78%	22%
B5	74%	26%	B6	60%	40%	B7	76%	24%
C5	43%	57%	C6	38%	62%	C7	44%	56%
D5	18%	82%	D6	17%	83%	D7	16%	84%
E5	18%	82%	E6	18%	82%	E7	18%	84%

Table 2
Results of Assays in the Mozley Concentrator for samples 5, 6, and 7.

In Table 2, it is observed that the fractions of interest, A and B, were

concentrated in metals and fraction C, although with less than 50%, has inter-

esting quantities of metals, and was not considered as waste.

Sample/ Fraction	METALS			NONMETALS		
	5	6	7	5	6	7
A	48%	65%	60%	11%	18%	12%
B	10%	13%	2%	3%	8%	0%
C	25%	7%	20%	27%	10%	18%
D	11%	3%	5%	39%	14%	20%
E	6%	12%	13%	20%	50%	49%

Table 3
Distribution of Metals and Nonmetals in each of the Fractions

Table 3 gives the amount of metals and nonmetals that remained in each fraction. In sample 5, 48% of metals and 11% of nonmetals were retained in fraction A, while in sample 6, 65% of metals and 18% of nonmetals were retained in fraction A. Thus, it is observed that it is possible to recover 83% (A + B + C), 85%, and 82% of the metals from samples 5, 6, and 7, respectively.

In the samples 5 and 6, chemical

analysis by flame atomic absorption spectrometry was performed, aiming to define if certain metals are distributed in preferred fractions. These samples were chosen because they have a greater content of metal recovery. The results are shown in Table 4.

As observed in Table 4, the results observed in Figure 4 are repeated in assays with the Mozley concentrator, since aluminum (due to its density) and gold

(due to its lamellar form) are preferably concentrated in the light fraction. However, it is possible to recover more than 80% copper, and greater than 90% of lead, tin, iron, nickel, silver, and zinc. Among the samples analyzed, it was observed that although the recovery of gold is higher in sample 5, the other metals are recovered in greater amounts in sample 6, which makes use of a lower tilt of the table as the best option.

Sample 5	Al (%)	Pb (%)	Cu (%)	Sn (%)	Fe (%)	Ni (%)	Au (%)	Ag (%)	Zn (%)
A	7	61	44	58	69	70	27	52	72
B	1	9	9	19	14	12	4	12	12
C	33	27	30	15	8	12	25	29	13
D	47	2	11	4	6	4	34	4	2
E	12	1	5	4	3	2	10	3	1
A+B+C	41	97	84	91	91	94	56	93	98
D+E	59	3	16	9	9	6	44	7	2

Sample 6	Al (%)	Pb (%)	Cu (%)	Sn (%)	Fe (%)	Ni (%)	Au (%)	Ag (%)	Zn (%)
A	14	78	61	72	82	79	25	71	90
B	5	16	13	13	12	12	5	20	8
C	15	3	11	10	2	5	10	7	1
D	18	0.5	3	1	1	1	21	0.3	0.2
E	48	2	12	4	4	3	40	2	1
A+B+C	34	98	85	95	95	96	39	98	99
D+E	66	2	15	5	5	4	61	2	1

Table 4
Metal Distribution of samples 5 and 6 in each of the Fractions.

Conclusions

With these assays, it is concluded that a particle size less than 1 mm provides good release of the metals contained in printed circuit boards.

From the assays, it was observed that the use of mechanical processes to obtain fractions concentrated in metals from PCB is feasible, which may sub-

stantially increase the efficiency of the subsequent processes, whether hydrometallurgical or pyrometallurgical. The greater efficiency in the use of Mozley concentrator was obtained when operated with a water flow of 0.4 L/min and a tilt-tray of 0.26°, using the configuration of the flowchart in Figure 6.

Using the Mozley concentrator, it is possible to recover concentrates containing up to 85% copper, 95% tin, 96% nickel, and 98% of the silver present in the printed circuit board. These metals are of great economic interest due to their market value or the amount present in PCB, such as copper, for example.

Acknowledgements

The authors would like to acknowledge the Capes, Cnpq and Fapergs.

References

- BANDINI, M., Seminário Internacional de Resíduos Eletroeletrônicos. Minas Gerais, Brasil, 2009. http://www.mma.gov.br/port/conama/reuniao/dir1088/PolNacResiduosSolidos_MarcosBandini_10dez09.pdf, October, 2012.
- CUI, J.^a; FORSSBERG, E. Mechanical recycling of waste electric and electronic equipment: a review. *Journal of Hazardous Materials*, v.B99, p.243-263, 2003.
- CUI, J.^b; ZHANG, L. Metallurgical recovery of metals from electronic waste: A review. *Journal of Hazardous Materials*, v.158, p.228-256, 2008.
- HAGELÜKEN, C.; MESKERS, C.E.M. Mining our computers - Opportunities and challenges to recover scarce and valuable metals from end-of-life electronic devices. *Proceedings of Electronics Goes Green*, p.623-628, 2008.
- IDC^a, Brasil comercializa 15,4 milhões de computadores em 2011 e se consolida na terceira posição do mercado mundial. <http://br.idclatin.com/releases/news.aspx?id=690>, October, 2012
- IDC^b, IDC revela que foram vendidos 7,8 milhões de computadores nos seis primeiros meses de 2012. <http://br.idclatin.com/releases/news.aspx?id=759>, October, 2012.
- Lei 12.305. Política Nacional de Resíduos Sólidos, 2 August 2010. http://www.planalto.gov.br/ccivil_03/_ato2007-2010/2010/lei/l12305.htm, October, 2012
- MURUGAN, R. V.; BHARAT, S., DESHPANDE, A. P.; VARUGHESE, S.; HARIDOSS, P. Milling and separation of the multi-component printed circuit board materials and the analysis of elutriation based on a single particle model. *Powder Technology*, v.183, p.169-176, 2008.
- SAMPAIO, C. H.; TAVARES, L. M. M. Beneficiamento Gravimétrico. Porto Alegre, 2005.
- SCHULUEP, M., et al. 2009. Recycling from e-waste to resources. United Nations Environment Programme. http://www.unep.org/PDF/PressReleases/E-Waste_publication_screen_FINAL-VERSION-sml.pdf, May, 2012
- TUNCUK, A.; STAZI, V.; AKCIL, A.; YAZICI, E.Y.; DEVECI, H. Aqueous metal recovery techniques from e-scrap: Hydrometallurgy in recycling. *Minerals Engineering*, v.25, p.28-37, 2012.
- VEIT, H. M.; DIEHL, A. P.; RODRIGUES, J. S.; BERNARDES, A. M.; TENÓRIO, J. A. S. Utilization of magnetic and electrostatic separation in the recycling of printed circuit boards scrap. *Waste Management*, v.25, p.67-74, 2005.
- WUPPERTAL INSTITUTE, Material Intensity of Materials, Fuels, Transport Services. http://www.wupperinst.org/uploads/tx_wibeitrag/MIT_2011.pdf, October, 2012
- ZHANG, S.; FORSSBERG, E.. Mechanical separation-oriented characterization of electronic scrap. *Resources, Conservation and Recycling*, v. 21, p. 247-269, 1997.

Artigo recebido em 26 de novembro de 2012. Aprovado em 12 de fevereiro de 2014.