

Combined axial and flexural loads in short reinforced concrete columns in fire: ultimate limit state curves using 500 °C isotherm method

Flexão composta oblíqua em pilares curtos de concreto armado em situação de incêndio: curvas do estado – limite último pelo método da isoterma de 500 °C



J. S. SUAZNABAR^a
jorge.suaznabar@usp.br

V. P. SILVA^a
valpigss@usp.br

Abstract

Ultimate limit state curves of short reinforced concrete columns in fire situation are going to be presented in this paper. The authors created a code developed in Matlab. It makes a discretization of the cross sections of the columns and calculates the equilibrium integrals of them. The curves were plotted with the code considering the 500 °C isotherm method.

Keywords: reinforced concrete columns, fire situation.

Resumo

Curvas envoltórias correspondentes ao estado – limite último de pilares curtos de concreto armado em situação de incêndio serão apresentadas neste artigo. Os autores criaram um código desenvolvido no programa Matlab. Esse código realiza uma discretização da seção transversal dos pilares e o cálculo numérico das integrais de equilíbrio. As curvas foram representadas graficamente com o código considerando o método da isoterma de 500 °C.

Palavras-chave: pilares, concreto armado, incêndio, flexão composta, isoterma de 500 °C.

^a Universidade de São Paulo, Escola Politécnica, Departamento de Engenharia de Estruturas e Geotécnica, São Paulo, SP, Brasil.

Received: 24 Jan 2016 • Accepted: 20 Jun 2017 • Available Online: 15 Feb 2018

 This is an open-access article distributed under the terms of the Creative Commons Attribution License

1. Introduction

Combined axial and flexural loads in short reinforced concrete columns in fire situation is a very new subject studied internationally [1] and [2]. Several aspects should be considered in order to

and the maximum strains. There is an extensive bibliography available, such as abacuses and simplified methods [3], [4], and more advanced numerical methods, for columns at room temperature [5]. But there is a smaller quantity for fire situation, among others, advanced software DIANA, ABAQUS, ANSYS and SAFIR.

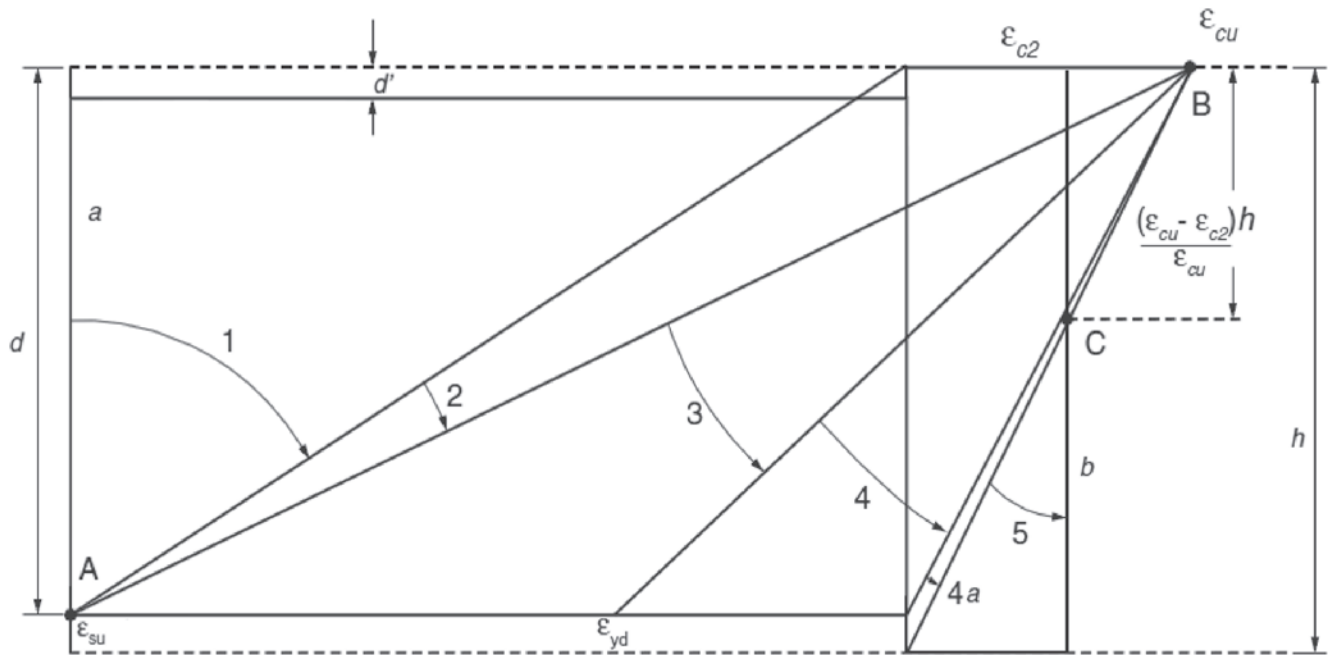

Figure 1
Pivot diagrams at room temperature

determine the safety of these structural elements, among others, the temperature field in the cross-section and the non-linearity of the materials. Consideration of these aspects increases the level of difficulty. As an option, a strategy is to define maximum values for strains and the pivot diagrams (Figure 1), and to apply them to create the ultimate limit state curves and surfaces, also called interaction curves and surfaces, that allow to verify the safety of the columns. They are function of, among others, the constitutive laws of concrete and reinforcing steel, the cross-section geometry

In Figure 1:

ϵ_{cu} : Strain conventionally corresponding to the ultimate limit state of the most compressed concrete fiber of a fully compressed cross-section.

ϵ_{c2} : Strain conventionally corresponding to the ultimate limit state of the less compressed concrete fiber of a fully compressed cross-section.

ϵ_{su} : Strain conventionally corresponding to the ultimate limit state of the tensioned reinforcing steel.

ϵ_{yd} : Strain corresponding to the beginning of the yield of the reinforcing steel.

h: Cross-section high.

In fire situation, these interaction curves are function (besides the mentioned variables) of the time. In order to generate these interaction curves in fire situation, two strategies can be considered [1], those that consider the moment-curvature relationship and those that consider the boundary strains according to pivot diagrams. Those pivot diagrams in fire situation are different of those used at room temperature, which should vary according to the temperature. The pivot diagrams have been studied in [6], they are presented in the Figure 2 and are part of more advanced researches in the same research group of the authors. However, using these domains implies a greater computational effort and allows the study of straight but not oblique composite bending of the columns [7].

In Figure 2:

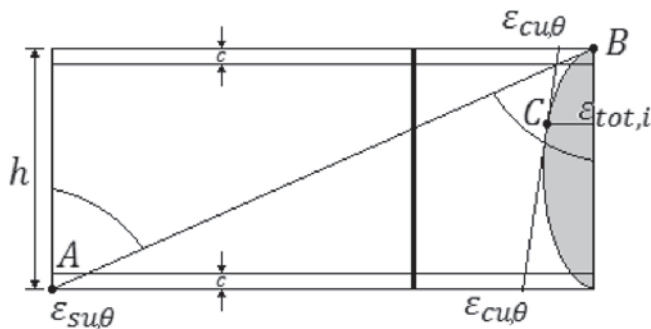

Figure 2
Pivot diagrams in fire situation

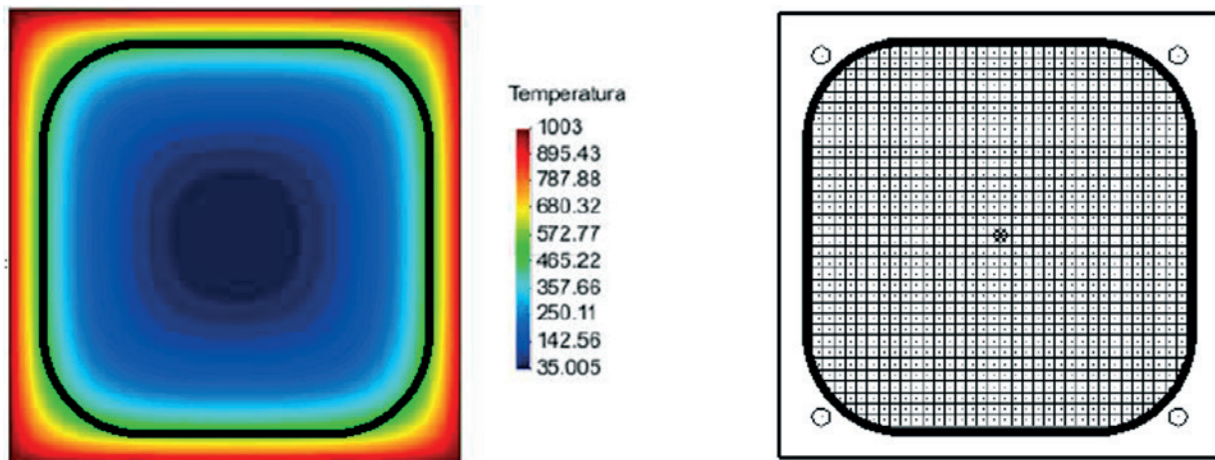

Figure 3
Discretized cross-section with the temperature field and the isotherm of 500 °C

$\varepsilon_{cu,\theta}$: Strain conventionally corresponding to the ultimate limit state of the compressed concrete at θ temperature.

$\varepsilon_{su,\theta}$: Strain conventionally corresponding to the ultimate limit state of the tensioned reinforcing steel at θ temperature.

$\varepsilon_{tot,i}$: Total strain in a point i of the fully compressed concrete cross-section.

The objective of this paper is to present a computational code developed in MATLAB [8] which, through numerical methods, accurately calculates forces and moments, strains and interaction curves for short columns of reinforced concrete in fire situation. It is considered the hypotheses of the 500 °C isotherm method to generate the interaction curves.

2. Method of the 500 °C isotherm

The method of the 500 °C isotherm is a simplified method created by the swedish researcher Dr. Yngve Anderberg. In 1978, Anderberg proposed the isotherm method of 550 °C, later the method was modified considering as limit the isotherm of 500 °C.

Considering a cross section in fire situation, with the known temperature field, the method of the 500 °C isotherm consists of assuming that concrete with temperatures higher than 500 °C is disregarded. In this way, only concrete with temperatures lower than 500 °C, i.e. the region of the inner cross-section at the 500 °C isotherm, is considered. In a simplified way, the concrete of this inner region is considered with the original properties at room temperature, even the the strains, however, with the exceptional coefficients. The reinforcement is considered with the properties of the reinforcing steel at the current temperature (in fire situation).

In **Figure 3**, an example cross-section with the 500 °C isotherm marked in the temperature field is presented and the concrete with a temperature greater than 500 °C is disregarded.

In spite of being considered a simplified method by EN 1992-1-2: 2004 [9], to apply this method it is necessary to use a thermal analysis program, to calculate the temperature field in the cross-section, which is not common in civil engineering.

3. Equilibrium of the cross-section

For the development of the software the following hypothesis were considered:

- In the cross-section, only the normal stresses are considered, the tangential stresses and the strains resulting from them are disregarded.
- The cross-section remains plane after deformation and the total strain is the result of summing the thermal and mechanical strains.
- There is bond between reinforcement and concrete.
- It is not considered geometric non-linearity related to the slenderness of the column.
- Thermal restrains are not considered.

Under the above hypothesis and for the region of the inner concrete section to the 500 °C isotherm, the cross section presented in **Figure 4** is considered to be in equilibrium if the system of equations 1 is satisfied.

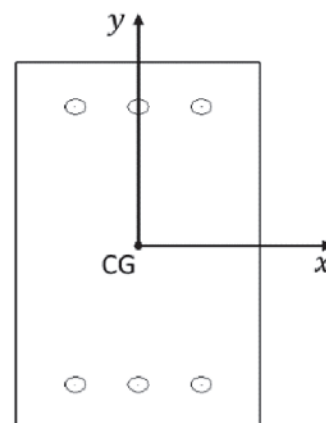

Figure 4
Reinforced concrete cross-section

In Figure 4:

CG: Geometric center of the cross-section.

$$S = \iint \sigma(\varepsilon)Z dx dy \quad (1)$$

In the system of Equations 1:

$$S = \begin{bmatrix} N \\ M_x \\ M_y \end{bmatrix} \quad Z = \begin{bmatrix} 1 \\ y \\ x \end{bmatrix}$$

Where:

N : Axial force.

M_x : Moment around the x-axis.

M_y : Moment around the y-axis.

In the system of Equations 1, the left-hand side represents the efforts in fire situation and the right-hand side represents the stresses and resistant forces (Figure 5).

All the efforts and stresses cited in this paper refer to fire situation. For simplicity, the subscript “θ” was not included. The values of those efforts must be calculated following the Brazilian code ABNT NBR 15200:2012 [10].

It should be noted that in this article, the ultimate limit state curves are calculated for short columns of reinforced concrete in fire situation, using the method of 500 °C isotherm. According to that, as explained previously, the stress and strength of concrete are those corresponding to the ambient temperature, and those of the reinforcing steel are those corresponding to the current temperature (in a fire situation).

In Figure 5:

ε_c : Strain of concrete.

ε_s : Strain of reinforcing steel.

f_c : Stress of concrete.

f_s : Stress of reinforcing steel.

N : Axial force.

M : Moment.

To solve the system of Equations 1, a cross section discretization is performed. In this way it is possible to solve the integrals quite pre-

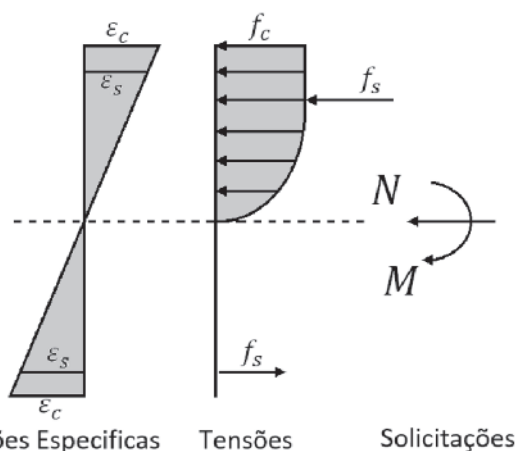

Figure 5
Equilibrium of the cross-section, at room temperature

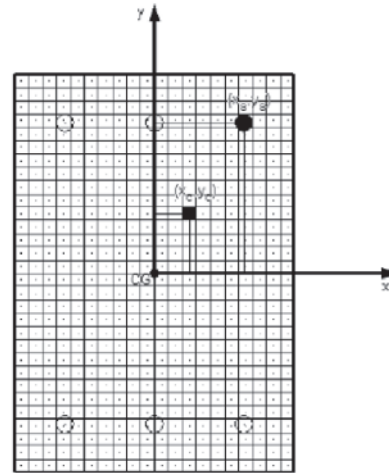

Figure 6
Discretized cross-section

cisely even when there are cross sections with unusual geometry.

3.1 Equilibrium of the discretized cross-section

The code developed by the authors allows to perform a discretization of the cross section, in square or rectangular elements. For the concrete, the strain and the stress are considered constant in each element and equal to the respective geometric center. For the reinforcement, which always have circular sections and small diameter in relation to the dimensions of the concrete cross-section, the strain and the stress are considered constant and equal to the respective geometric center of each reinforcement bar. In areas where there is overlap between the concrete and the reinforcement, the stress of the concrete corresponding to that area of the reinforcement is subtracted.

Next, the equilibrium formulation is presented for the discretized section, which is analogous to the formulation already presented. In this formulation the subscript “e” indicates that it is referring to a generic element “e”.

After the discretization, an element of the discretized section can be considered in equilibrium if the system of Equations 2 is satisfied.

$$S_e = \iint \sigma_e(\varepsilon_e)Z_e dx dy \quad (2)$$

In the system of Equations 2, we have:

$$S_e = \begin{bmatrix} N_e \\ M_{xe} \\ M_{ye} \end{bmatrix} \quad Z_e = \begin{bmatrix} 1 \\ y_e \\ x_e \end{bmatrix}$$

In an analogous way to the system of Equations 1, in the system of Equations 2 the left-hand side represents the efforts in fire situation related to the element and the right-hand side represents the stresses and resistant forces related to the element.

For the complete cross-section, already discretized, the system of equations 1 can be expressed according to the system of Equations 3.

$$\begin{aligned}
 N &= \sum_{i=1}^{nec} \sigma_{ci}(\varepsilon_{ci})A_{ci} + \sum_{i=1}^{nes} \sigma_{si}(\varepsilon_{si})A_{si} \\
 M_x &= \sum_{i=1}^{nec} \sigma_{ci}(\varepsilon_{ci})y_{ci}A_{ci} + \sum_{i=1}^{nes} \sigma_{si}(\varepsilon_{si})y_{si}A_{si} \\
 M_y &= \sum_{i=1}^{nec} \sigma_{ci}(\varepsilon_{ci})x_{ci}A_{ci} + \sum_{i=1}^{nes} \sigma_{si}(\varepsilon_{si})x_{si}A_{si}
 \end{aligned} \tag{3}$$

In system of Equations 3:

N : Axial force.

M_x : Moment around the x-axis.

M_y : Moment around the y-axis.

σ_{ci} : Stress of the concrete element i .

σ_{si} : Stress of the reinforcing steel element i .

ε_{ci} : Strain of the concrete element i .

ε_{si} : Strain of the reinforcing steel element i .

A_{ci} : Area of the concrete element i .

A_{si} : Area of the reinforcing steel element i .

x_{ci} : Coordinate x of the geometric center of the concrete element i .

y_{ci} : Coordinate y of the geometric center of the concrete element i .

x_{si} : Coordinate x of the geometric center of the reinforcing steel element i .

It should be noted that the stress distribution is considered constant in the cross section of each element, therefore adequate discretization is required to obtain a good stress distribution in the cross section of the column.

4. Ultimate limit state curves

Under the assumptions given above, for a set of efforts in fire situation, the code applies strain fields to the cross-section and evaluates the system of Equations 3. This process is performed in an iterative way until the equilibrium is satisfied. However, it is simpler to apply the conventional strains of the ultimate limit state and to calculate the stresses related to these strains.

To generate the ultimate limit state curves, it is sufficient to define

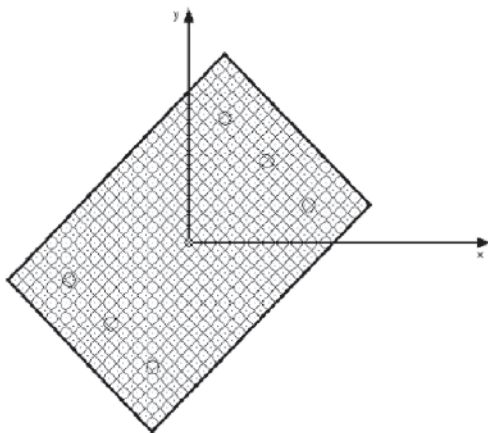

Figure 7
Discretized cross-section, under rotation of the longitudinal axis of the column

the conventional rupture strains at room temperature (remembering that the method of the 500 °C isotherm is being applied) and calculate the stresses associated with these strains.

It is worth noting that if it is necessary to obtain only the ultimate limit state curve $N - M_x$, all the strain fields have in common, rotations about the x axis, since there is no M_y moment.

For the $M_x - M_y$ moments ultimate limit state curve the code applies rotations to the cross section around the longitudinal axis of the column (Figure 7) and then applies the strain fields to the rotations about the x axis. It is worth remembering that for these moment ultimate limit state curves, the axial force is constant.

5. Materials

In the developed code, the recommendations of EN 1992-1-1: 2004 [4] and ABNT NBR 6118: 2014 [11] were used for the stress-strain curves of concrete and reinforcing steel at room temperature. The recommendations of EN 1992-1 and ABNT NBR 15200: 2012 [10] were used for the stress-strain curves of concrete and reinforcing steel in fire situation.

Next, the stress-strain diagrams for concrete and reinforcing steel will be presented at both conventional and fire situation.

5.1 Materials at room temperature

For materials at room temperature, EN 1992-1-1: 2004 [4] and ABNT NBR 6118: 2014 [11] recommend the use of the strain-strain curves of Figure 8 and Figure 9 given by Equations 4 and Equations 5 for compressed concrete and reinforcing steel respectively.

$$\begin{aligned}
 \sigma_c &= \alpha_{cc} f_{cd} \left[1 - \left(1 - \frac{\varepsilon_c}{\varepsilon_{c2}} \right)^n \right] \\
 0 &\leq \varepsilon_c \leq \varepsilon_{c2} \\
 \sigma_c &= \alpha_{cc} f_{cd} \\
 \varepsilon_{c2} &\leq \varepsilon_c \leq \varepsilon_{cu}
 \end{aligned} \tag{4}$$

In Equations 4:

f_{cd} : Design compressive strength of concrete.

α_{cc} : Coefficient of the strength of concrete under long duration loading.

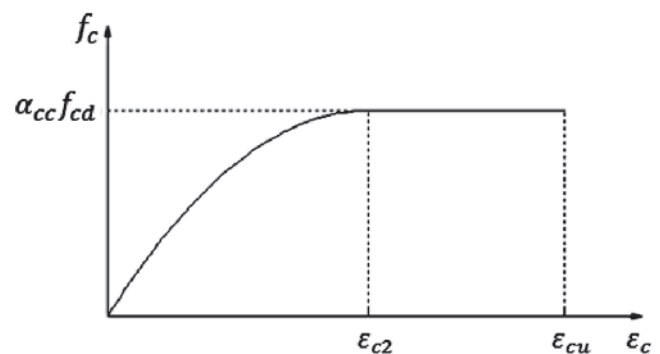

Figure 8
Stress-strain curve of compressed concrete at room temperature

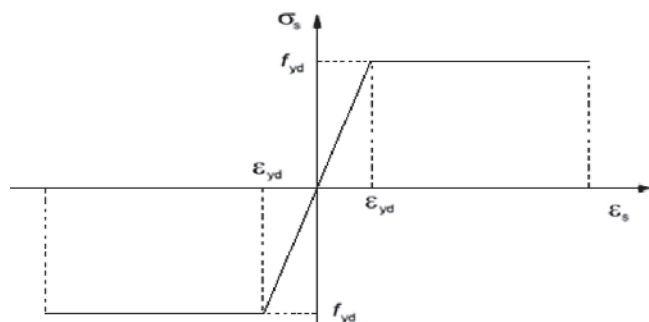

Figure 9
Stress-strain curve of reinforcing steel at room temperature

For $|\varepsilon_s| \leq \varepsilon_{yd}$

$$f_s = E_s \varepsilon_s$$

For $\varepsilon_s > \varepsilon_{yd}$

$$f_s = f_{yd}$$

For $\varepsilon_s < -\varepsilon_{yd}$

$$f_s = -f_{yd}$$

In Equations 5:

E_s : Modulus of elasticity of reinforcing steel.

f_{yd} : Design strength of reinforcing steel.

5.2 Materials in fire situation

For the materials in fire situation, EN 1992-1-2:2004 [9] and ABNT NBR 15200:2012 [10] recommend the stress-strain curves of Figure 10 and Figure 11 given by Equation 6 and Equations 7 for compressed concrete and reinforcing steel respectively.

$$\frac{\sigma_{c,\theta}}{f_{c,\theta}} = \frac{3 \left(\frac{\varepsilon_{c,\theta}}{\varepsilon_{c1,\theta}} \right)}{2 + \left(\frac{\varepsilon_{c,\theta}}{\varepsilon_{c1,\theta}} \right)^3}$$

$$\sigma_{s,\theta} = \varepsilon_{s,\theta} \cdot E_{s,\theta}$$

$$0 \leq \varepsilon_{s,\theta} \leq \varepsilon_{p,\theta}$$

$$\sigma_{s,\theta} = f_{p,\theta} - c + \frac{b}{a} \cdot \sqrt{a^2 - \left(\varepsilon_{y,\theta} - \varepsilon_{p,\theta} + \frac{c}{E_{s,\theta}} \right)^2}$$

$$\varepsilon_{p,\theta} \leq \varepsilon_{s,\theta} \leq \varepsilon_{y,\theta}$$

$$\sigma_{s,\theta} = f_{yk,\theta}$$

$$\varepsilon_{y,\theta} \leq \varepsilon_{s,\theta} \leq \varepsilon_{t,\theta}$$

$$\sigma_{s,\theta} = f_{yk,\theta} \cdot \left[1 - \frac{(\varepsilon_{s,\theta} - \varepsilon_{t,\theta})}{(\varepsilon_{u,\theta} - \varepsilon_{t,\theta})} \right]$$

$$\varepsilon_{t,\theta} \leq \varepsilon_{s,\theta} < \varepsilon_{u,\theta}$$

$$\sigma_{s,\theta} = 0$$

$$\varepsilon_{s,\theta} \geq \varepsilon_{u,\theta}$$

In Equations 6 and 7:

(5)

(6)

(7)

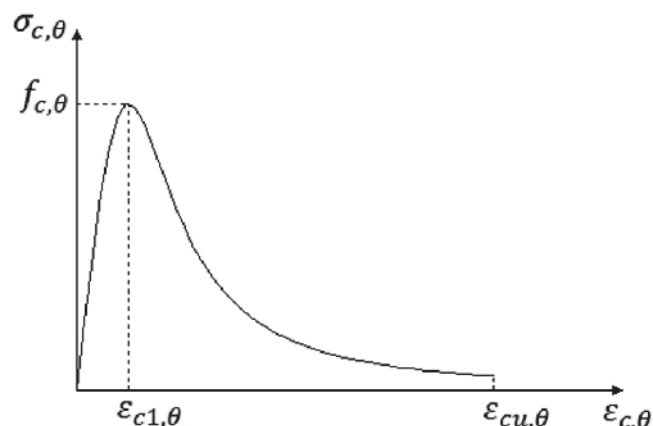

Figure 10
Stress-strain curve of compressed concrete in fire situation

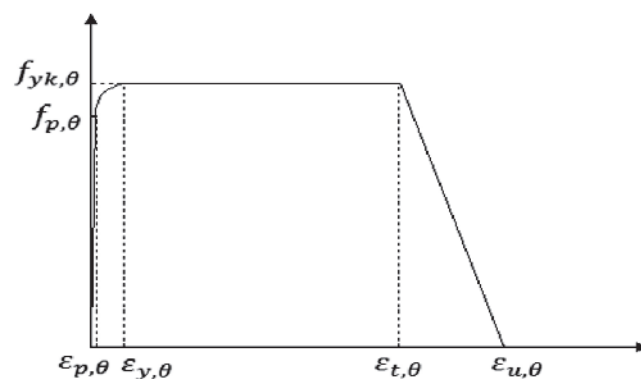

Figure 11
Stress-strain curve of reinforcing steel in fire situation

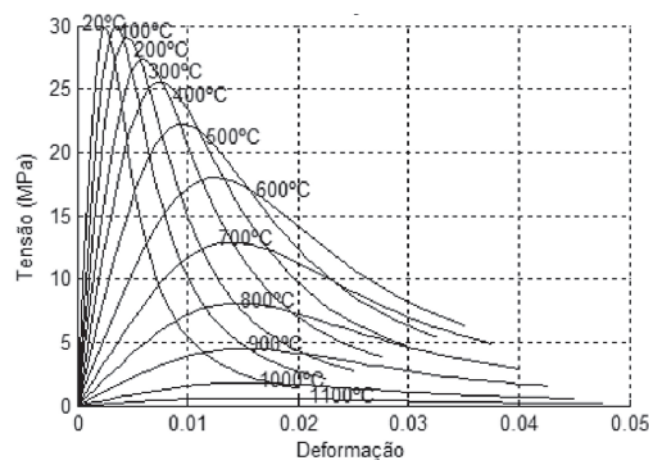

Figure 12
Stress-strain curves of concrete varying with temperature

¹ Average humidity estimated for the city of Foz do Iguaçu (Brazil).

² Average value based on report from IPCC [27].

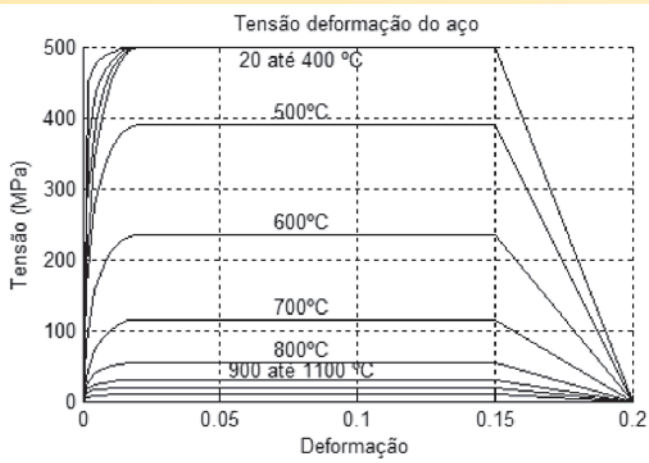

Figure 13
Stress-strain curves of reinforcing steel varying with temperature

$\sigma_{(c,\theta)}$: Stress of concrete at θ temperature.
 $\epsilon_{(c,\theta)}$: Strain of concrete at θ temperature.
 $\sigma_{(s,\theta)}$: Stress of reinforcing steel at θ temperature.
 $\epsilon_{(s,\theta)}$: Strain of reinforcing steel at θ temperature.

As an example, the stress-strain curves of a concrete $f_c = 30$ MPa for various temperature values (Figure 12) and strain-strain diagrams of the CA50 reinforcing steel, $f_y = 500$ MPa, for various temperature values are shown below (Figure 13).

6. Results and comments

The mechanical analysis of reinforced concrete structures in fire situation considering the method of the 500 °C isotherm, were performed using the code developed in MATLAB [8]. For this, the thermal analyzes were performed with the DIANA program, whose results were used in the mechanical analysis mentioned.

The concrete and reinforcing steel properties are $f_{ck} = 30$ Mpa and $f_y = 500$ Mpa, $E = 210$ GPa, respectively.

Two cross-sections of 30 cm x 30 cm with 4 ϕ 16 mm (Figure 14.a) and 8 ϕ 16 mm (Figure 14.b) were studied with discretization in 1 cm x 1 cm square elements.

Afterwards, the thermal analyzes were performed for 30 min, 60 min, 90 min and 120 min of exposure to the standard curve ISO 834 (1999) [12]. The corresponding temperature fields are shown in Figures 15.a, 15.b, 15.c and 15.d respectively.

Once the temperature fields are known, the code disregards concrete with temperatures higher than 500 °C, considering only the inner concrete at the 500 °C isotherm with the properties at room temperature. The reinforcement, regardless of position, were considered at their current temperature (in fire situation).

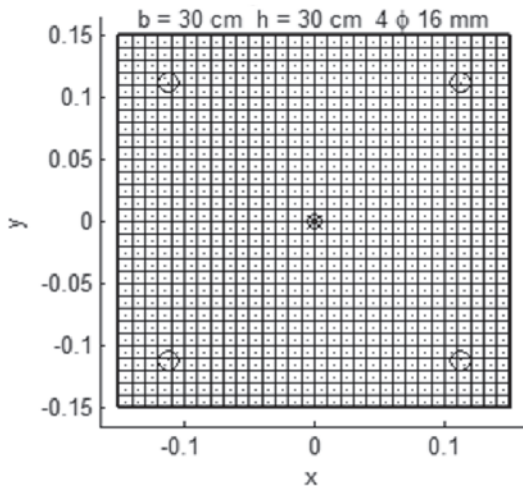

Figure 14a
Cross-section with 4 ϕ 16 mm

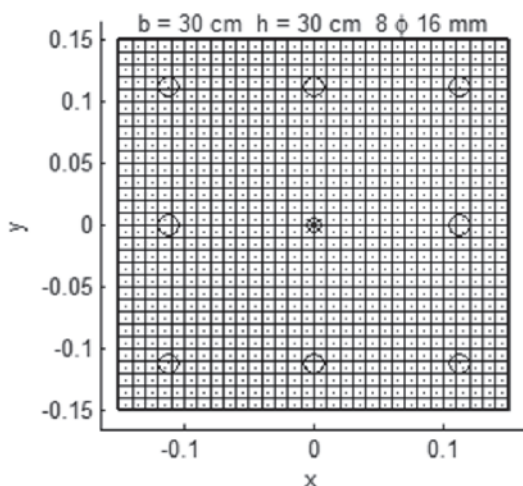

Figure 14b
Cross-section with 8 ϕ 16 mm

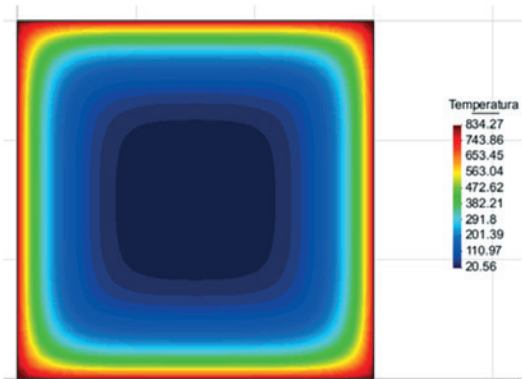

Figure 15a
Temperature field for 30 min

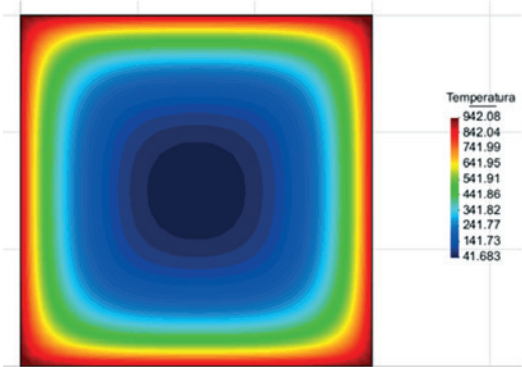

Figure 15b
Temperature field for 60 min

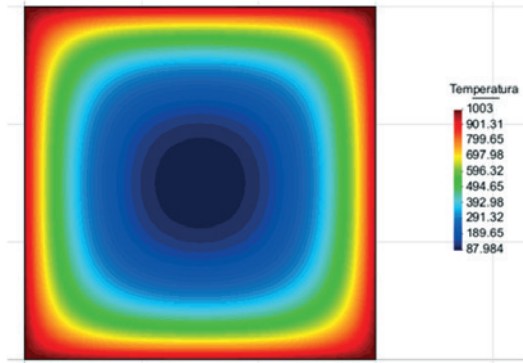

Figure 15c
Temperature field for 90 min

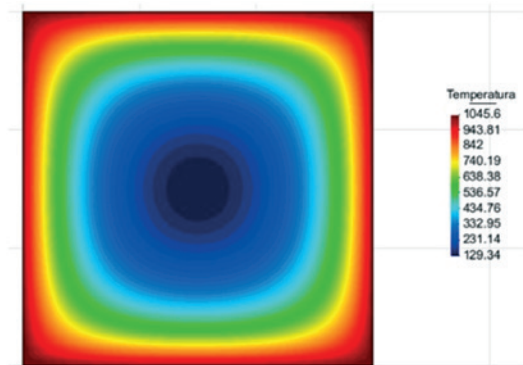

Figure 15d
Temperature field for 120 min

Finally, the mechanical analysis was performed verifying the equilibrium with the calculation of the system of Equations 3. It is recalled that the limit deformations of the concrete were considered at room temperature.

The ultimate limit state curves N-M and N-M_x-M_y were obtained as a result. N, M_x and M_y are the calculation efforts corresponding to the fire situation.

Then, in Figures 16.a and 16.b, the N-M curves of the two cross

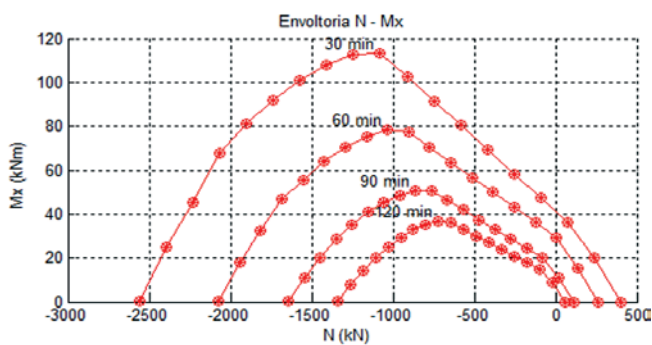

Figure 16a
N-Mx curves of the cross-section 30 cm x 30 cm with 4 φ 16 mm

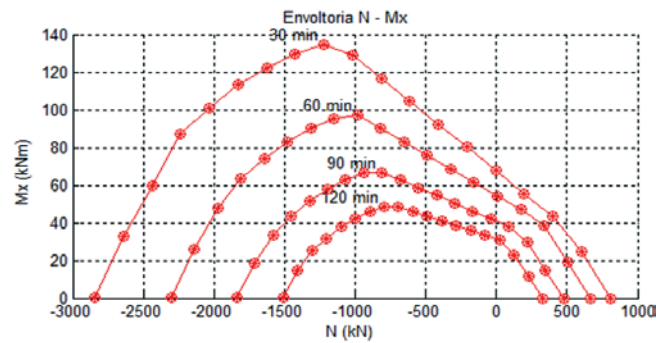

Figure 16b
N-Mx curves of the cross-section 30 cm x 30 cm with 8 φ 16 mm

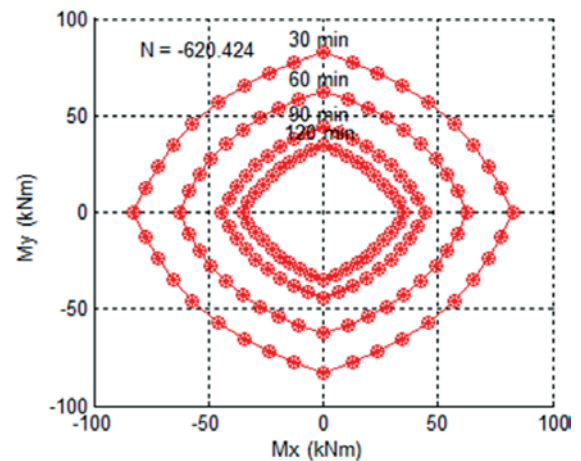

Figure 17a
M_x - M_y curves of the cross-section with 4 φ 16 mm for $N_{N_{cmax20}} = 0.20$

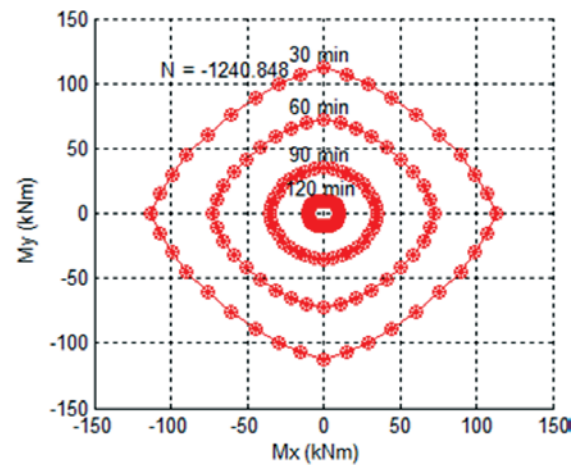

Figure 17b
M_x - M_y curves of the cross-section with 4 φ 16 mm for $N_{N_{cmax20}} = 0.40$

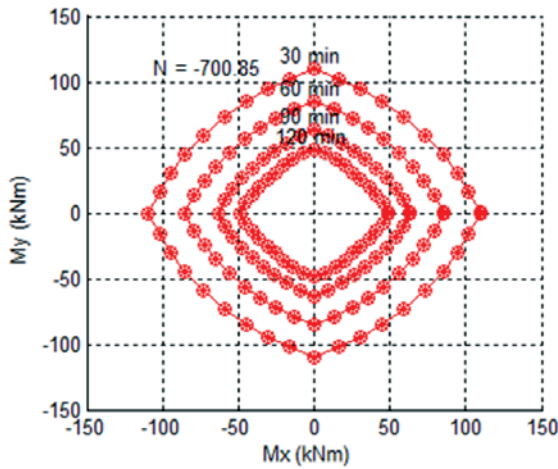

Figure 17c
 $M_x - M_y$ curves of the cross-section with 8 ϕ 16 mm for $N_{N_{cmax20}} = 0.20$

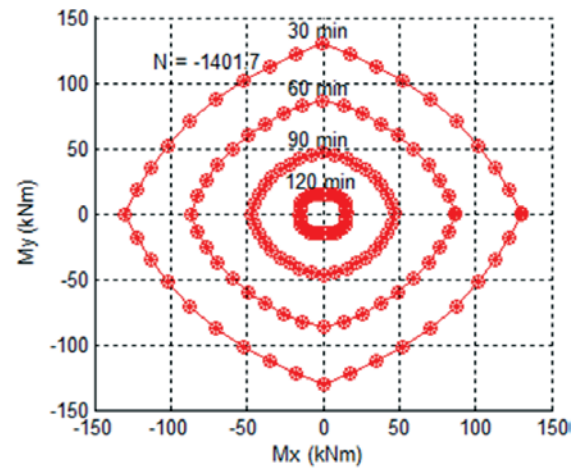

Figure 17d
 $M_x - M_y$ curves of the cross-section with 8 ϕ 16 mm for $N_{N_{cmax20}} = 0.40$

sections under study (Figures 14.a and 14.b) are presented for the mentioned temperature fields (Figures 15.a, 15.b, 15.c and 15.d) considering the method of 500 °C isotherm.

It is observed that the longer the exposure time to fire, the lower the strength of the column, with a reduction of more than 50% of the axial compressive strength (relative to its capacity at room temperature) when the column is exposed 120 minutes.

Figure 17a, 17.b, 17.c and 17.d show the $M_x - M_y$ curves of the two cross sections under study for the 30, 60, 90 and 120 min temperature fields of exposure to fire ISO 834 (1999) [12], considering the isotherm method of 500 °C, for 3 constant axial loads.

In the previous figures N_{cmax20} is the maximum axial strength in compression at room temperature of the column.

The column strength decreases when temperature and/or axial loading increase.

It should be noted that each point marked on the interaction curves corresponds to a calculated solution of the system of Equations 3.

It is also noted that in this article the thermal deformation restrictions were not considered.

The decrease of the maximum axial strength of centered compression of the sections shown in Figures 14.a and 14.b for the standard fire exposure times shown in Figures 15.a, 15.b, 15.c and 15.d is shown in Table 1.

In this paper all the coefficients of strength and the effects of decreasing the concrete strength with time (Rüsch effect, etc.)

were considered unitary since they were problems associated with exceptional short-term situations.

The code developed by the authors of this paper is being developed in addition to the method of the 500 °C isotherm, in order to perform mechanical analysis considering the variation of stress-strain diagrams as a function of temperature and the variation of stresses in the cross section (Figure 18).

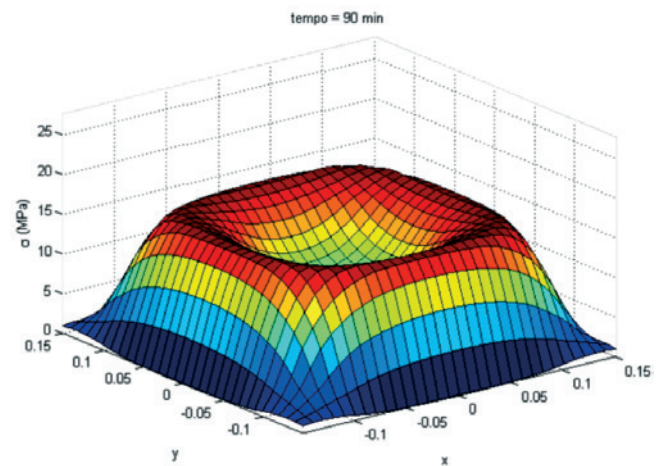

Figure 18
 Stress field of the cross-section 30 cm x 30 cm with 4 ϕ 16 mm under axial compression

Table 1

Decrease of axial strength as a function of time of exposure to fire

30 cm x 30 cm	N_{max20}	$N_{max\theta} / N_{max20}$				
		0 min	30 min	60 min	90 min	120 min
4 ϕ 16 mm	3,102.12 kN	1	0.84	0.68	0.55	0.45
8 ϕ 16 mm	3,504.25 kN	1	0.80	0.65	0.53	0.43

7. Conclusions

In order to perform numerical modeling of short columns of reinforced concrete in a fire situation, the use of the 500 °C isotherm method proved to be a suitable strategy.

The computational code developed for this article was able to generate ultimate limit state curves using the method of the 500 °C isotherm, combined with a method that solves the integrals and systems of equations using a discretization of the cross section.

As expected, the results showed that the longer the exposure time to fire the higher the temperature in the cross section, therefore the lower the strength of the column. The results also showed that the higher the compressive force on the column, the shorter the time it reaches the ultimate limit state.

Finally, it is emphasized that the mathematics used to study the phenomena studied involves systems of equations with integral of non-linear equations. The resolution of these systems of equations was possible using approximate methods with discretization of the cross section considered in the academic environment as advanced methods.

8. Acknowledgments

The authors thank CAPES “Coordenação de Aperfeiçoamento de Pessoal de Nível Superior”, CNPq “Conselho Nacional de Pesquisa e Desenvolvimento Científico” and FAPESP “Fundação de Amparo à Pesquisa do Estado de São Paulo”.

9. References

- [1] FÉDÉRATION INTERNATIONALE DU BÉTON. Fire design of concrete structures – structural behavior and assessment. State of art report. Lausanne, 2008.
- [2] FÉDÉRATION INTERNATIONALE DU BÉTON. Fire design of concrete structures – materials, structures and modelling. State of art report. Lausanne, 2007.
- [3] MESEGUER, A. G.; CABRÉ, F. M.; PORTERO, J. C. A. Jimenez Montoya – Hormigón Armado. Gustavo Gili, Barcelona, España, 2009.
- [4] EUROPEAN COMMITTEE FOR STANDARDIZATION. EN 1992-1-1. Eurocode 2: Design of concrete structures – part 1.2 General rules and rules for buildings. Brussels: CEN, 2004.
- [5] RODRIGUEZ, J.A.; ARISTIZABAL, O.D. Biaxial Interaction Diagrams for Short RC Columns of Any Cross Section. *Journal of Structural Engineering*. v. 125, p. 672-683, 1999.
- [6] SUAZNABAR, J.S.; SILVA, V.P.; PIERIN, I. Estudo dos Domínios de Deformação em Seções Transversais de Concreto Armado em Situação de Incêndio. 56 Congresso Brasileiro do Concreto. Natal, 2014.
- [7] SUAZNABAR, J.S.; SILVA, V.P. Flexão composta de pilares curtos de concreto armado sob incêndio não simétrico. 3 Congresso Ibero-Latino-Americano Sobre Segurança Contra Incêndios. Porto Alegre, 2015.
- [8] SUAZNABAR, J.S.; SILVA, V.P. Code for combined axial and flexural load on short RC columns: failure surfaces. XXXVI Jornadas Sudamericanas de Ingeniería Estructural. Montevideo, 2014.
- [9] EUROPEAN COMMITTEE FOR STANDARDIZATION. EN 1992-1-2. Eurocode 2: Design of concrete structures – part 1.2 General rules – structural fire design. Brussels: CEN, 2004.
- [10] ASSOCIAÇÃO BRASILEIRA DE NORMAS TÉCNICAS. NBR 15200: Projeto de estruturas de concreto em situação de incêndio. Rio de Janeiro, 2012.
- [11] ASSOCIAÇÃO BRASILEIRA DE NORMAS TÉCNICAS. NBR 6118: Projeto de estruturas de concreto: Procedimento. Rio de Janeiro, 2014.
- [12] INTERNATIONAL ORGANIZATION FOR STANDARDIZATION ISO 834-1:1999(E). Fire-resistance tests – Elements of building construction – Part 1: General requirements. Ginebra, 1999.