

Judgement in geotechnical engineering practice

José António Mateus de Brito^{1#} 

Lecture

Keywords

Judgment in geotechnical engineering
Expert judgment
Codification
Incidents and accidents
Cut and cover excavations
Pile support systems

Abstract

Professional judgement is the basis for many of the decisions taken by geotechnical engineers to make progress in the design, execution and works supervision. Judgment is a mandatory component of any engineering achievement, essential to assess the various uncertainties that inevitably affect engineering practice. Confidence in such judgements can result in small to big consequences, not only for the engineer itself, but also for others, sometimes with the risk of human loss and significant damage. The definition and the development of judgment in geotechnical engineering is discussed. The bases of the judgement are analysed in detail and the heuristics and bias, responsible for failures in the judgment, are identified. The importance of experts' judgement and codification are highlighted and ways to improve judgment are also described. The lessons learned in a case study of one accident and two incidents that have occurred during the execution of the Lisbon Terreiro do Paço metro station construction works are presented to highlight the importance of an informed decision making informed through the engineering judgement.

1. Judgment in geotechnical engineering

1.1 Introduction

Judgment is paramount in engineering practice as it results from the use of intuition and reasoning, as well as from a fragment of codes, practical rules, applied science and evaluation and management processes. In various decisions concerning, for example, the option to stabilize a slope with a nailed shotcrete lining instead of an anchored structure, or the option for a rockfill dam solution on a rocky foundation, as an alternative to a concrete dam, the geotechnical engineer needs judgment to take his decisions and guide his actions. As pointed out by Parkin (2000), these judgments are informed by experience, expertise, reasoning or analysis. They are carried out during the development of the process, or after silent deliberation, and may be the result of solitary work on the computer or the result of extensive consultation, conflict and persuasion. From immediate to strategic, judgments define the structure of engineering.

To better understand what judgment is, it is relevant to look at its etymology. It is found in latin as *iudicium*, resulting from the verb *iudicare*, which means to judge. This verb, in turn, is composed of *ius*, which is fair, and *dicere*, which means to say. It is also possible to go to the Indo-European

root of this verb and find **deik-*, which has the meaning of showing and pronouncing with solemnity. Thus, it is clear that judgment is the competence to pronounce what is correct, which is why it is also defined as the use of discernment, which in turn implies the separation between right and wrong.

The art of geotechnical engineering has been described as the ability to make sound decisions face up to imperfect knowledge. The resulting decisions and forecasts always incorporate uncertainty to a lesser or greater degree, so the engineer has to apply judgment, that is, the very real interpretive process that results from the sum of experience, discernment and intuition. Sometimes judgements under uncertainty are quantified as numerical probabilities (subjective probabilities), using the same laws of statistic probabilities (Vick, 2002).

The uncertainty of knowledge in geotechnical applications is subdivided into three subcategories: uncertainty in the geological-geotechnical characterisation, uncertainty of models and uncertainty of parameters.

Judgement, as it is used in geotechnical engineering, is also used in other engineering specialities and in other professions which have to face uncertainties, like medicine.

1.2 Soil engineering problem solving

Five decades ago, right in the introduction to the Soil Mechanics and Foundations class of Instituto Superior

#Corresponding author. E-mail: jmateusdebrito@gmail.com

¹TPF - Consultores de Engenharia e Arquitetura, S. A., Lisboa, Portugal

Submitted on March 1, 2021; Final Acceptance on March 3, 2021; Discussion open until: Invited Lecture. No discussions.

<https://doi.org/10.28927/SR.2021.063821>

 This is an Open Access article distributed under the terms of the Creative Commons Attribution License, which permits unrestricted use, distribution, and reproduction in any medium, provided the original work is properly cited.

Técnico, in Lisbon (Mineiro, 1971), when geotechnicians of a new generation were taking their first steps in geotechnics, it was taught that the resolution of a soil engineering problem was a combination of various factors and knowledge, almost always differently from case to case, and that the ability to judge became indispensable to achieve the best solution, and also that the satisfactory solution of soil engineering problems always involved the combination of soil mechanics and one or more components, including geology, experience and economics as shown in Figure 1 (Lambe & Whitman, 1969). This was one of the quotes that immediately alerted and sensitized to the importance of the practice of engineering judgement and that now accompanies the professional life of so many geotechnicians. It is also the inspirational quote of the theme of this paper. The motivation for this reflection resulted from practising the professional activity of geotechnical engineering and from the raised questions of whether the judgements that were being made in the projects, taken as engineering decisions and actions, would be the most appropriate ones.

These combined factors turn any problem involving soils unique and, for all practical purposes, impossible to obtain an exact solution. Hence the importance of robust engineering judgement. Lambe & Whitman (1969) appropriately state that while a sound knowledge of soil mechanics is essential to a successful soil engineer, engineering judgement is usually the distinguishing feature of the exceptional soil engineer. This was, however, a seldom explored aspect of the judgement as before it was restricted to the final decision-making phase of the geotechnical process, after gathering all the knowledge about the process in question. However, it was neither defined nor known what the engineering judgement really was, and what kind of knowledge and preparation was required to make judgments, what were the heuristics and bias and associated uncertainties, as well as which risks were involved. Nevertheless, it had the advantage of combining judgement together with other components of geotechnics, which, to a certain extent, was a precursor of the progressive relevance that the judgement has acquired over the last 50 years.

The main question that arises when talking about judgement are as follows (adapted from Marr, 2019):

- All engineers use judgement, but how do they use it?

- How do you develop the ability to make engineering judgements?
- How do you know if the judgment made is robust and how can it be improved?
- What is the importance of judgement in geotechnical engineering? In which areas it is most relevant?
- What are the heuristics and bias from the judgment?
- Are most of judgements risks related? Do our judgments have risks? Does our risk assessment depend on judgment?
- To what extent can structured judgments contribute to the development of geotechnical engineering?

1.3 What is the engineering judgement?

Judgment is a cognitive ability of our brain leading us or not to make decisions and develop actions. In institutional settings, where major objectives shape our behaviour, we use reasoning and, maybe, analysis to help judgment (Parkin, 2000). Marr (2006) seeks to be more objective, defining judgment as the exercise of thinking clearly, logically and calmly about a problem, weighing the known facts, suppositions, missing information and consequences and then taking a decision. It is the ability to arrive at sensible decisions about a problem in the presence of incomplete and contradicting information. To demonstrate the importance of the judgement, Table 1 is presented, highlighting the central role that the judgement plays in the four phases where the geotechnical engineering process is developed: defining, investigating and characterizing, analysing, designing (prediction), and observing and evaluating (Marr, 2006, 2020). In each one of these phases, critical thinking skills are required, and therefore judgment plays a central role in all phases of the geotechnical engineering process.

The geotechnical process is largely a matter of decision-making in an environment that is inherently uncertain and requires much judgment. At each stage of the process, judgments are often made throughout the day. It is the most important ability beyond the mental and physical skills and the five senses.

An important concept linked to judgment is the subjective probability, which is defined as the probability of an uncertain event that corresponds to the quantitative

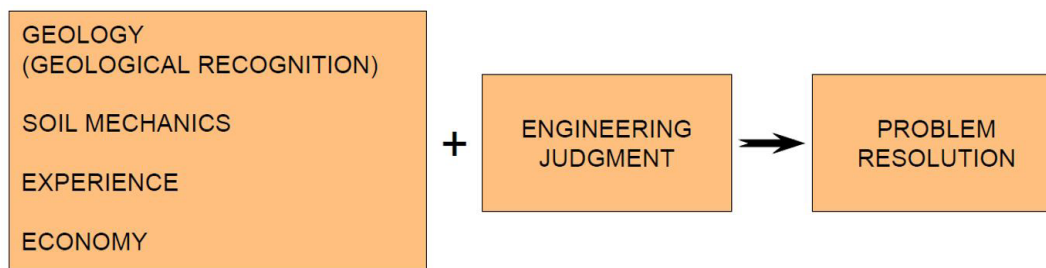

Figure 1. The solution of problems of soil engineering (Lambe & Whitman, 1969).

Table 1. Judgement in the stages of the geotechnical engineering process (Marr, 2006).

STEP	DESCRIPTION
Define, Investigate and Characterize	Define project needs, then gather relevant information and data. Use interpolation, extrapolation, deduction and inference, along with <u>judgement</u> , to develop a generalized mental and analytical model of the subsurface conditions
Analyze	Use evaluated information, empirical correlations, engineering knowledge and <u>judgement</u> to determine input parameters for the mental and analytical model to analyse and predict possible performance. Use <u>judgement</u> to fill data gaps and simplify complex projects conditions to render a manageable model
Design	Apply the mental and analytical model to determine specific requirements for the design to meet project requirements. Develop trial designs. Use <u>judgement</u> to assess viability, safety and constructability of design options and select the optimal combination for project conditions. Use model and <u>judgement</u> to predict the performance of the final design
Observe and Evaluate	Monitor actual performance during construction and operation. Question models and <u>judgement</u> where unexpected outcomes occur. Use models and <u>judgement</u> to modify remaining construction or operating conditions where needed. Learn and document what to do differently next time

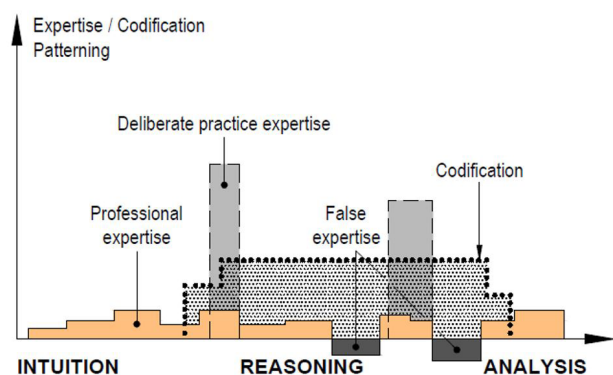

Figure 2. Specialization, codification and cognitive continuum (adapted from Parkin, 2000).

measure of the subjective evaluation (or belief) in the result, according to the state of knowledge at the time it is evaluated. Subjective probability can be considered, in a simpler way, as the quantified expression of a judgment or opinion about the likelihood of an uncertain event. Naturally, the judgment is inseparable from the individual and, therefore, it is inherently subjective, making the subjective probability go hand in hand with the judgment.

1.4 The development of the judgement

Bandura (1986), considered the father of social cognitive theory, showed that human functioning is determined by the interaction of personal characteristics, behaviour and environmental factors. Each influences the others in time and all influence all stages of the judgment function for action. People do not perceive the same attributes (or clues) or do not reach the same conclusions. How do this ability to make sound judgments develop? Margolis (1987) in his treatise on cognition and judgement indicates that it is a natural step in contemporary brain evolution. The steps of cognitive development appear to be seven: simple feedback, pattern recognition, learning, choice, intuitive judgment, reasoning, and calculation.

Intuitive judgment is an innate skill that is shared by humans with other mammals, which developed during the prehistory of our species. Reasoning, on the other hand, has probably developed together with language over the last 100,000 years. Finally, our ability to develop mathematical analysis is very recent and has to be formally learned (Parkin, 2000).

In recent times intuitive judgement has been supplemented and helped by reasoning and calculation. The relationship between these three functions in modern judgement can be explained by the extension of Brunswick’s (Brunswik, 1952) perception research, which provided the basis for the study of intuitive judgement called cognitive continuum theory (Hammond, 1996). How do people use their reasoning skills and intuitive judgment to track modern technical and social problems? According to Hammond (1996) the answer lies in the ability to go back and forth between the intuitive mode and the more analytical mode, during the period of time necessary to reflect on the problem and arrive at a judgment, as outlined in Figure 2, adapted from Parkin (2000). This figure shows the fluctuation of the intensity of professional specialisation along the cognitive continuum from intuition to analysis with the nature of the task. In some situations, errors related to rules or knowledge resulting from false specialisation may manifest. It turns out that no matter how analytical the engineers may be, in the end the intuitive judgement is always present. It is evident that what we can calculate, allows us to make better judgements and result in better engineering solutions.

1.5 Biases and heuristics of the judgement

Over the past 70 years, research into the psychology of judgement and decision-making has shown that human judgement fails due to many cognitive biases. In practice, people use simple mental strategies or practical rules to simplify the task of quantifying subjective probabilities. In cognitive psychology, this is called heuristics. Heuristics lead to systematic errors called cognitive biases. The conclusion is that people use practical rules to simplify judgments that do not follow the standards. In any area of human knowledge, it

appears that judgment is affected by a series of heuristics to simplify the processing of cognitive data. These are useful in making the job simpler, but also divert personal judgements to a number of directions, particularly to the reasoning region of the cognitive continuum. These biases are important, but in real dynamic situations, the ability to correct these judgments have been developed over time with the disclosure of new data. Faulty judgments are essentially the result of reasoning that deals incorrectly with lack of data, irrelevant data, erroneous assumptions, ambiguities, poor verification, mood effects, irrational thoughts and incorrect probabilistic thoughts. These failed judgments result in consequences that can be more significant and bigger than generally imagined. Wikipedia ([en.wikipedia.org/wiki/List of cognitive biases](http://en.wikipedia.org/wiki/List_of_cognitive_biases)) give 124 examples of cognitive bias. From the 30 cognitive biases on this list, which Marr (2020) considered to affect the judgment of geotechnical engineering, the most common ones are given in Table 2.

When making judgments to fill data gaps in information and knowledge, engineers intrinsically make subjective assessments of the importance of the various uncertainties, that is, they make a subconscious risk assessment weighing the uncertainties and assessing the potential consequences of possible outcomes of decisions and recommendations.

Table 2. List of some cognitive biases that affect judgment in geotechnical engineering (Adapted from Marr, 2020).

COGNITIVE BIAS	DESCRIPTION
Availability	Over-relying on information that's readily available or easily recalled
Authority bias	Attributing greater accuracy and more influence by opinion of an authority figure
Concrete information	Putting higher value to information from our own experience or that of trusted colleagues rather than abstract information in a document
Conservation bias (belief revision)	Favouring prior evidence over new evidence
Information bias	Biased conclusions resulting from inaccurately measured or classified data or information
Neglect of probability	Disregarding probability when making a decision involving uncertainty
Not invented here	Aversion to ideas, products or methods developed by others
Overconfidence	Having more confidence in the accuracy of individual's knowledge, judgements and actions than is justified
Self-serving bias	Claiming more responsibility for successes than failures
Shared information bias	Spending more time and energy discussing already familiar things and less time on unfamiliar things

But they take shortcuts with consequent biases that might lead to faulty results. Most engineers deal with uncertainty using heuristics that ignore many of the most basic rules of probability. A surprising number of engineers take subjective probabilities for granted, considering them coherent and calibrated while in fact they are not (Baecher & Christian, 2003). This is why probabilistic thinking needs to be taught and practiced.

1.6 Expert judgement

An expert is a person trained in a particular domain and the specialization can be found throughout the cognitive continuum. Being an expert involves knowledge and practice. Expert judgment can be developed using judgments from any region of the cognitive continuum and can vary in the degree of specialization. Short-term memory (working memory) can only absorb, store and process between 5 and 9 cues of information at any given time (Simon, 1981). Specialization in a domain of knowledge can represent between 50,000 and 100,000 cues of information stored in long-term memory. Achieving a state of specialization requires about 10 years of continuous deliberate practice and this practice must be maintained if the level of specialization is to be kept high. Considerable deliberate practice, consisting of trial and error and feedback during this period, is necessary to fully develop specialization in a domain of knowledge or practice (Parkin, 2000).

One of the aspects that distinguishes a professional from a beginner is the degree to which he is able to accumulate experience and implement this to new situations. In fact, what is important is not to accumulate any experience, but to accumulate assessed experience. When applied appropriately, engineering judgement reflects accumulated and assessed experience (Baecher & Christian, 2003).

As Marr (2019) states, experts are characterised by:

- Being excellent in their own domain;
- Realizing high standards in their own domain;
- Solving problems quickly with few errors;
- Having superior short-term and long-term memories;
- Seeing and representing a problem in their domain at a deeper level than beginners;
- Spending considerable time analysing a problem qualitatively;
- Having strong self-regulatory skills.

The deliberate practice of specialisation, unavailable to most professionals, is represented as a narrow but intense block, which can be located in any area of the cognitive continuum (Figure 2). Naturally, the further one goes to the analytical side of the cognitive continuum, the more defensive the judgments will be, but the intuitive element will always be present.

It should be noted that no matter of excellent the experts may be, it is not possible to eliminate the subjective nature of judgements, consequently neither the uncertainty and

probability of their failure. One might make judgments in an environment of imperfect mental models using uncertainty and incomplete information processed by a biased mind, which leads to potentially failed judgments.

1.7 Codification

A high degree of specialisation among professionals is rare due to the fact that few professionals deliberately use the practice in their learning strategies, taking little advantage of reliable feedback during professional practice. Professional work does not go wrong more often due to the collective capacity to externalise specialisation in the form of practical rules, codes, standards and specifications. Codification makes a large degree of specialisation unnecessary for good professional practice (Parkin, 2000). Figure 2 shows that the codification increases in the reasoning-analysis zone of the continuum, but neglects the intuitive zone and the extreme of the continuum that depends on the creative use of mathematics, using computational models, each time more complex, that help to strengthen knowledge and reduce uncertainties.

1.8 Judgement and risk

Risk is the effect of uncertainty on objectives, whether positive or negative, as defined in NP ISO 31000 (2012). It is the combination of the probability of an uncertain event times the consequences. Risks are associated with the possibility that judgments will lead to wrong decisions or assessments. There are important uncertainties in risk analysis that are not susceptible to a quantitative assessment based on data and have been addressed using professional judgment and expert opinion based on intuition, past experience and other qualitative beliefs.

Risk assessment creates a way to quantify the uncertainty in judgements and decisions and to communicate that degree of uncertainty. Risk management is a systematic process of identifying, analysing, planning, observing, communicating and responding to risk, in order to reduce uncertainty. So, judgment and risk are closely linked. It is necessary to recognise this fact and its consequences and to develop a better understanding of the links and better use of tools to identify, quantify and manage risk.

1.9 How to obtain and improve the judgment of geotechnical engineering

Where to get the ability to make engineering judgments and how to develop and improve this ability? These themes are not explicitly included in the geotechnical disciplines in university programmes or in engineering textbooks. Apart from applied analysis science, not much is taught in modern engineering courses and universities and is not easy to find experienced design staff. The practice of project and project management has been learned for many years through

immersion in a specialised project environment. Young engineers will become progressively more useful as they work backwards in analysing and detailing the demanding art of project design. Analytical techniques are now aided by software sets, often linked to graphical outputs. This analysis and modelling are often mistakenly referred to as a project and an undue emphasis is placed on its performance in universities.

Some of the relevant information on judgement in geotechnical engineering is thanks to Ralph Peck. During his long career as a professor and engineer, with talent, hard work, perseverance and good judgement, he made several contributions that drew attention to the importance of engineering judgement (Peck, 1969, 1980, 1981, Dunnycliff & Deere, 1984, NGI, 2000, Dunnycliff & Nancy, 2006). In a video (Peck, 1991) interesting topics are presented stating that successful engineering practice requires a high degree of engineering judgment, with a sense of proportion being one of the main facets of engineering judgment, and without which an engineer cannot test the results of a calculation in relation to its reasonableness (ability to establish criteria for reasonable behaviour for the design).

There is a clear message from some eminent geotechnicians like Terzaghi, Peck and Lambe, that good judgement results from evaluated experience that is learned not only from one's own experience but also from that of the others. Thus, in order to improve judgement, it is necessary to disseminate the experiences more, good or bad, as well as the respective results. The complexity of the project and innovation will continue to challenge the limits of human cognition, and it is important to ensure that safety is maximized at each stage of the engineering process. To do this properly, geotechnicians should be free to add to their domain of knowledge the causes of bad behaviour and rupture by learning from incidents and disasters as soon as they occur.

From the literature of judgment and personal practical experience, the following suggestions can be added to obtain and improve the judgment of geotechnical engineering:

- Get a good education and follow the literature; young engineers should have experts as mentors, in order guide them on how errors can be avoided or quickly corrected and should be encouraged to develop skills in drafting, drawing and make rough calculations as a safety precaution against inadequate computer analysis;
- Make a career plan and obtain a variety of training and experience in the first years of their profession even if it is necessary to change to new employers to find the right job and mentoring; civil engineers who wish to practice on design should be encouraged to have one or two years of experience on site, as early as possible in their careers; as these field experiences will remain in the memory for a lifetime and will fundamentally enrich the clues available in the short-term memory during the project process;

- Increase the power of observation and develop the ability to register what is seen;
- Expand the evaluation of the experience by obtaining feedback from own judgments to learn what went well and wrong, to improve future decision-making; get field experience and feedback during construction; visit other works and study their results;
- Be well grounded in the theoretical bases of the models and their limitations and have simple methods of checking and gaining a sense of proportion;
- Identify and understand the gaps in knowledge and data and the implications of these gaps in the judgments;
- Avoid impulsive or stressful decisions; instincts can cause the loss of the main facts and the benefits of deliberate thinking; sleep on the main decisions, because their subjective results can change with more reflection;
- Maintain the connection with experts in the knowledge domain so that errors can be avoided or corrected;
- Consider the effects of our own decisions made with stakeholders - customers, owners, users, public and the company itself;
- Be confident that judgements and decisions can be justified to third parties;
- Have the main calculations and drawings reviewed by an experienced engineer using different tools; for innovative or large-scale projects or when the safety of the population and the possible damage caused by the deficient behaviour of the works are factors to be considered in the project; all key calculations and drawings should be verified by an experienced independent consulting firm;

- Maintain humility in knowledge and openness to learn from one's own mistakes;
- Remain open to questioning, revision, reflection, learning and failure;
- Document and reflect on successful and failed judgements.

2. Lessons learned from incidents occurred during the construction of a major geotechnical works: Terreiro do Paço metro station in Lisbon

2.1 Introduction

Terreiro do Paço metro station is part of the Blue Line of the Lisbon Metro, located in the zone that connects Baixa-Chiado Metro Station to Santa Apolónia Metro Station. It started operating at the end of 2007. The station is located between the east building of Terreiro do Paço Square, occupied by the Finance Ministry, and the south and southeast maritime station, a ground floor building already built in the 20th Century (Figures 3 and 4). A large part of the station's implantation area was reclaimed from the river with fills, placed before and after the 1755 earthquake.

The metro tunnel was previously executed with a tunnel boring machine (TBM) between 1997 and 1999. At the site, the tunnel axis is located at an average depth of 19 m (-16.00 m elevation), all its section excavated in the smooth alluvial deposits of the Tagus River, where thickness reaches about 26 m in the station area (Figure 4).

After the construction of the tunnel, during the early phase of the station construction according to the initial

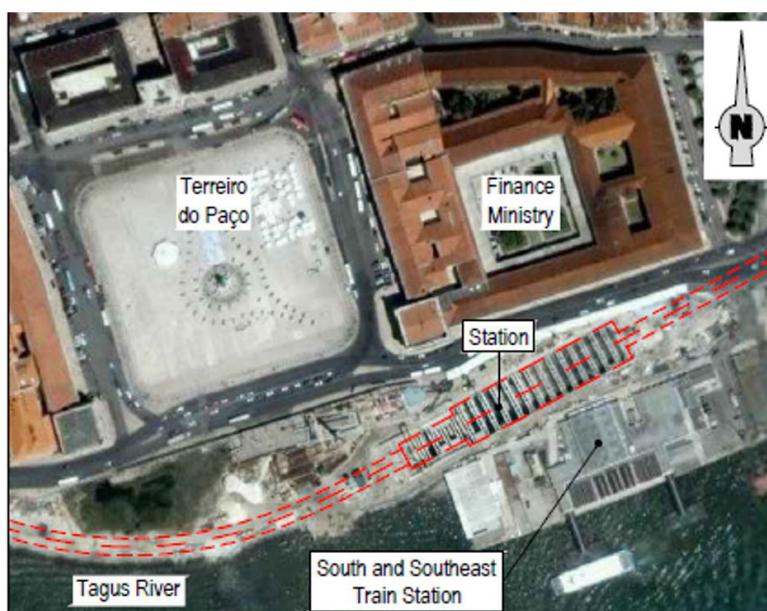

Figure 3. General plan of the site and of the station (Brito & Fernandes, 2006a).



Figure 4. View of the eastern area of Terreiro do Paço square and the Finance Ministry building, with the location of the tunnel and the station (Brito & Fernandes, 2006a).

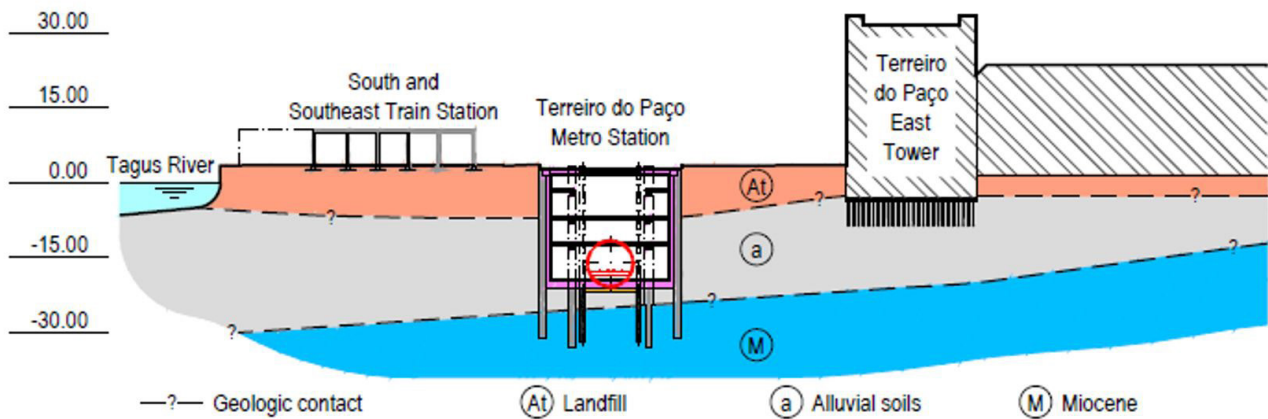

Figure 5. Schematic section across the Tagus River, the station and the east tower of Finance Ministry (Brito & Fernandes, 2006a).

project, in mid-2000, an accident of a certain severity occurred. This accident began during the first phase of the station’s west portal treatment by drilling holes in the lower prefabricated lining segments of the tunnel for the execution of jet grouting. Strong run-off of water and sandy soils began flowing through these holes into the tunnel, with the consequent subsidence of the terrain surface located above the tunnel.

The works on the station were restarted in 2001, following a new project, and completed in 2006. In the final phase of excavation inside the station, in 2003, two incidents of some gravity occurred, with the entry of water and sandy clay alluvial deposits through openings between the retaining wall piles, when the fifth and final phase of excavation was to be carried out. Given the risk of another incident of a similar nature (considering the uncertainty of the position of the piles), the excavation and retaining works were interrupted for a period of 8 months for a better study of the situation and also for the analysis of possible mitigation solutions to be implemented prior to the restart of the works.

2.2 Geological conditions

Figure 5 includes a simplified geological transversal section to the station axis. The substratum is composed of Miocene formations, covered by soft alluvial deposits and fills. The surface of the substrate descends progressively towards the river with a slight inclination towards S-SW.

Figure 6 shows a longitudinal geological profile of the northern wall of the station. As reported by Brito & Fernandes (2006a), landfill soils with variable thickness occur in depth, sometimes mixed with alluvial deposits, containing stones and obstacles, sometimes of large dimensions. This is followed by the predominantly clay-muddy alluvial deposits, ranging from soft clays to sands (some very clean). However, there is a very significant predominance of clean sands at the base of the alluvial deposits. Underlying the alluvial deposits are the Miocene formations, consisting of clays from “Forno do Tijolo”, with a hard consistency, interspersed with layers of dense sands with artesianism.

It can be seen in Figure 6 that around the zone of the tunnel accident and in incident areas of the station, there are soft clays and small layers of clean sands of medium to fine grain size.

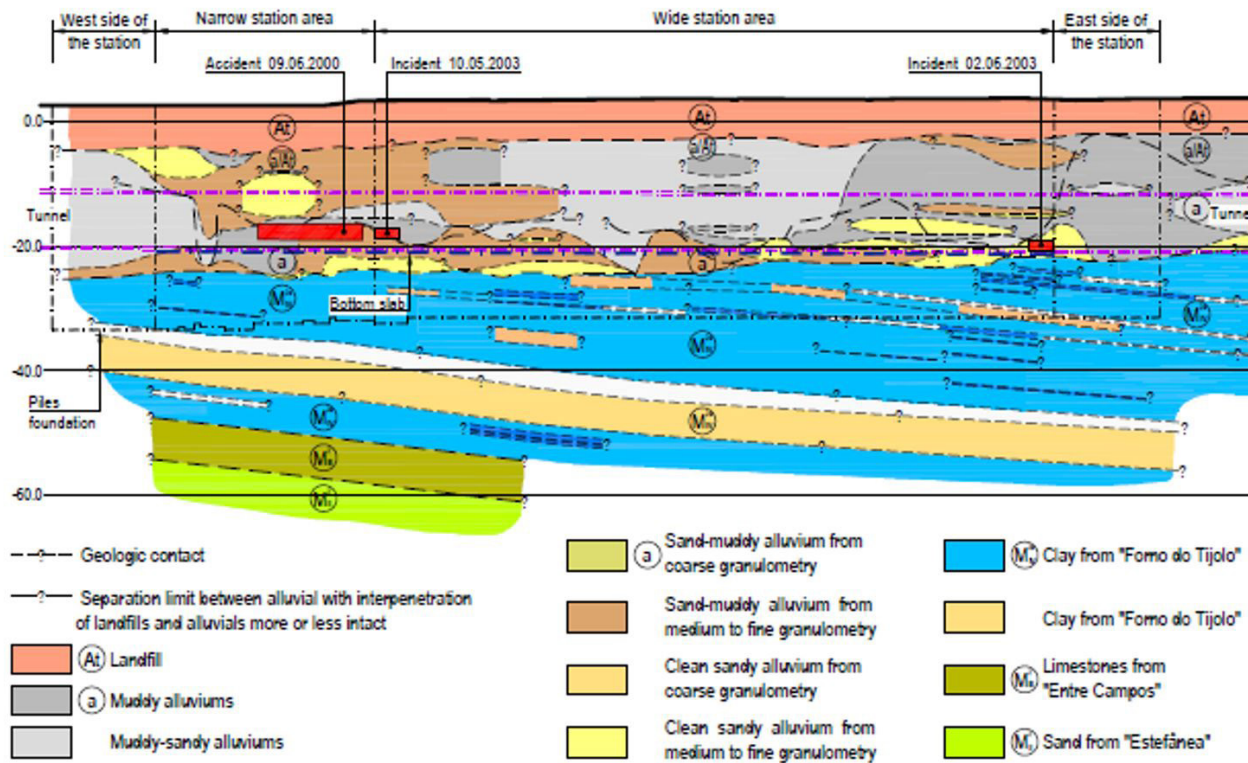

Figure 6. Longitudinal geological profile corresponding to the north side of the tunnel and the station with the location of the tunnel accident and the station incidents (Brito & Fernandes, 2006a).

2.3 Tunnel accident occurred on 9 June 2000

2.3.1 Treatment solution for the west portal

Due to the accident occurred during the initial works of the station first project, the tunnel structure was seriously damaged along about 25 m. After this accident, the tunnel was initially filled with water and, in a second phase, with light plastic concrete, along a length corresponding to that of the future station, plus about 20 m next to each portal (Salgado, 2014). This information was relevant for the design of the new station structure and its connection to the tunnel structure at the two portals.

Figure 7 a show a cross-section with the two phases, foreseen in the initial project of the station, for the execution of consolidation and waterproofing jet grouting columns of the surrounding area of the west portal. In this initial project the jet grouting columns would be executed from inside the tunnel, in a first phase, and from the top of the landfill soils in a second phase. Figure 7 b show a section of the initial project with the location plan of the jet grouting columns to be executed from inside of the tunnel, with a total of 243 columns with 0.8 m diameter and length of 4 to 6 m in triangular pattern of 0.6 m (Ferconsult, 2001). It was specified that the length of the carotred holes should not exceed what was strictly necessary to cross the concrete lining of the

tunnel, in order to avoid puncturing the cement of the exterior injections made during the tunnel construction. However, this condition would have been difficult to meet given that the inclination of the holes was vertical or close to vertical.

Initially 13 holes with 152 mm diameter were drilled to allow the subsequent execution of jet grouting, but water and soil entered the last hole drilled. Meanwhile, water and soil began to appear in another two holes, and the site was abandoned by the staff. In four hours, there were signs of structural damage and water entering through the lining joints of the tunnel. Simultaneously with the entry of water and soil, settlements and cracking occurred in front of the tower of the Finance Ministry building (Salgado, 2014).

2.3.2 Immediate stabilising measures

It was observed that the greatest impact on the surface was located in a restricted area of the landfill in front of the tower of the Ministry of Finance building, with a record maximum settlement of 230 mm.

The stabilising measure was filling the tunnel with water to counteract the ingress of water and soil into the tunnel, in order to minimise damage and reduce settlements on the surface. To do this, concrete plugs had to be made in the shafts situated in the tunnel in mid distances to the adjacent

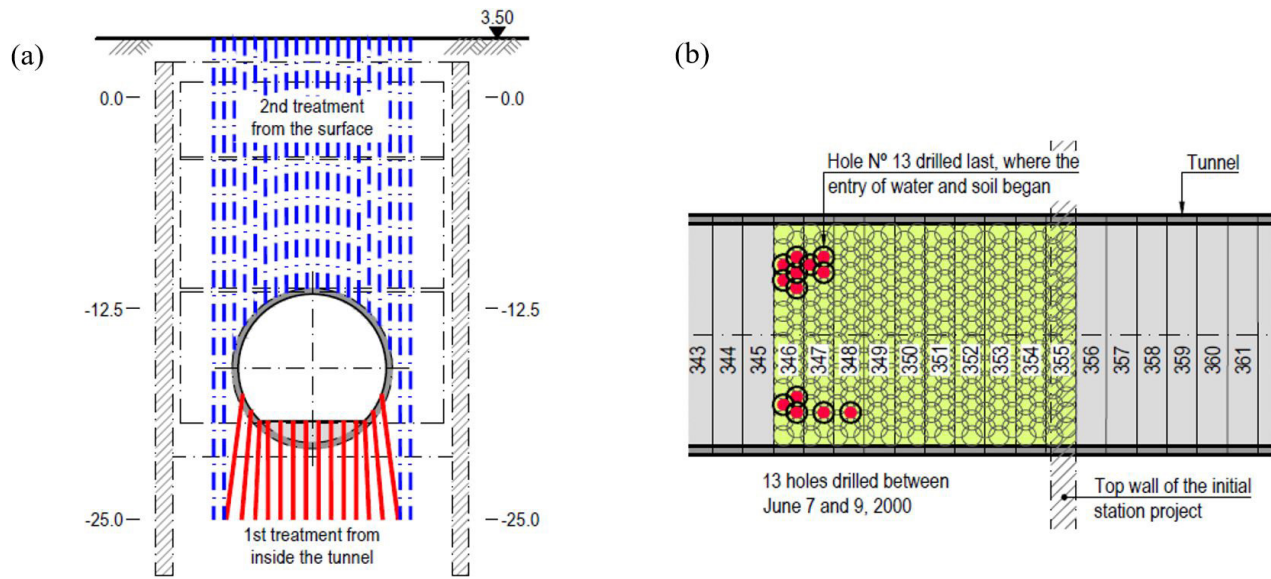

Figure 7. (a) Execution phases of the jet grouting columns of the west portal; (b) Location plan of the columns to be executed from inside the tunnel and the holes executed before the incident occurred (adapted from Ferconsult, 2001).

stations. The filling with water, done in four phases, as the concreting in the plugs continued, took place for about a month.

Given the favourable evolution of the tunnel settlements, measured after filling with water, inspections were carried out inside the tunnel with an underwater robot coupled with a video camera and also by divers, which confirmed that the most affected area coincided with the 345 to 349 concrete lining segments. Subsequently, in the excavations made to build the station, it was possible to visualize the tunnel's extrados in the most affected area, as illustrated in Figure 8.

The horizontal deformations recorded in this area reached a maximum of about 60 cm, resulting from the temporary imbalance of the tunnel confinement due to the phenomenon of liquefaction that occurred following the drilling carried out. On the south side, no pathologies were detected in the tunnel lining nor any deformations were observed.

2.3.3 Reinforcement and stabilisation actions in the medium term

For the reinforcement of the tunnel in the incident area, taking into account that after the reinforcement it would be necessary to carry out the excavation in the incident area for the construction of the future station, it was decided to fill the tunnel with lightweight concrete placed in several phases, through holes in the upper part of the tunnel, after the previous execution of three gravel plugs at west, east and in the central area of the new station.

The reinforcement works were successfully completed about 6 months after the incident, when the total stability was restored and the displacement rates observed were already low.

2.3.4 Instability mechanism

The cause of this accident was the inability of the sandy soils to resist the high hydraulic gradients occurred in some of the holes drilled in the tunnel, thus initiating a process of static liquefaction with the consequent entry of water and soil into the tunnel, as schematically represented in Figure 9 a.

The mechanism of the flow of soil particles into the tunnel resulted from:

- High hydraulic gradient, due to a large difference in water pressure over a very short distance (outside and inside the tunnel);
- Unconfined surface, allowing the particles to flow freely through the holes in the concrete lining;
- Incoherent soils with relatively high permeability, made up of sands and silty sands, very susceptible to liquefaction.

The nature and thickness of the sandy alluvial deposits surrounding the tunnel in the west portal (presence of thin or thicker sand layers) was critical to the occurrence of this incident. The deposition environment in estuary, where sediments are frequently rearranged due to tidal currents, causing a rapid change in the type of soil deposited, was conducive to the formation of these randomly oriented thin sandy layers, interspersed in the finest deposits and even of alluvial sand layers with greater expression.

2.3.5 Lessons learned

In the initial design phase of the station, the accident was predictable based on existing information. However, there was only the concern that the holes would not be in

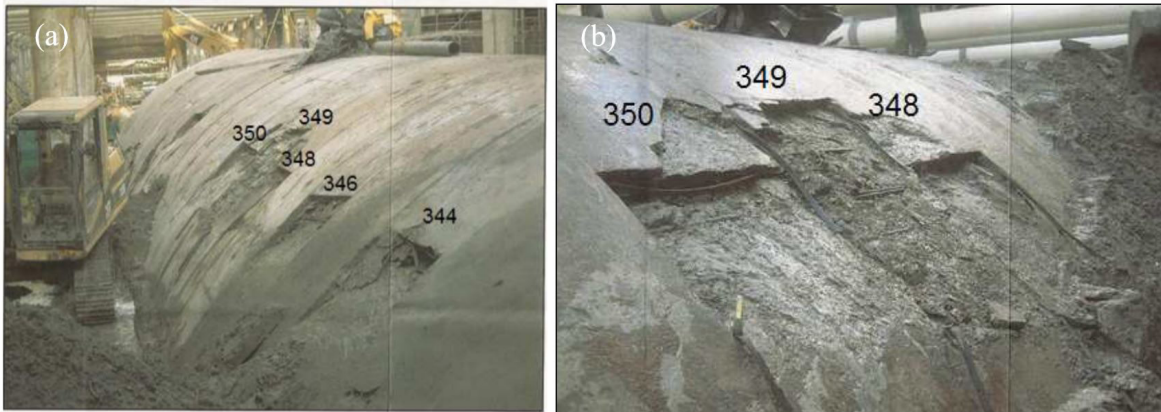

Figure 8. Views from the east and west sides of the lining segments 344 to 350 of the extrados of the north side of the tunnel (Salgado, 2014).

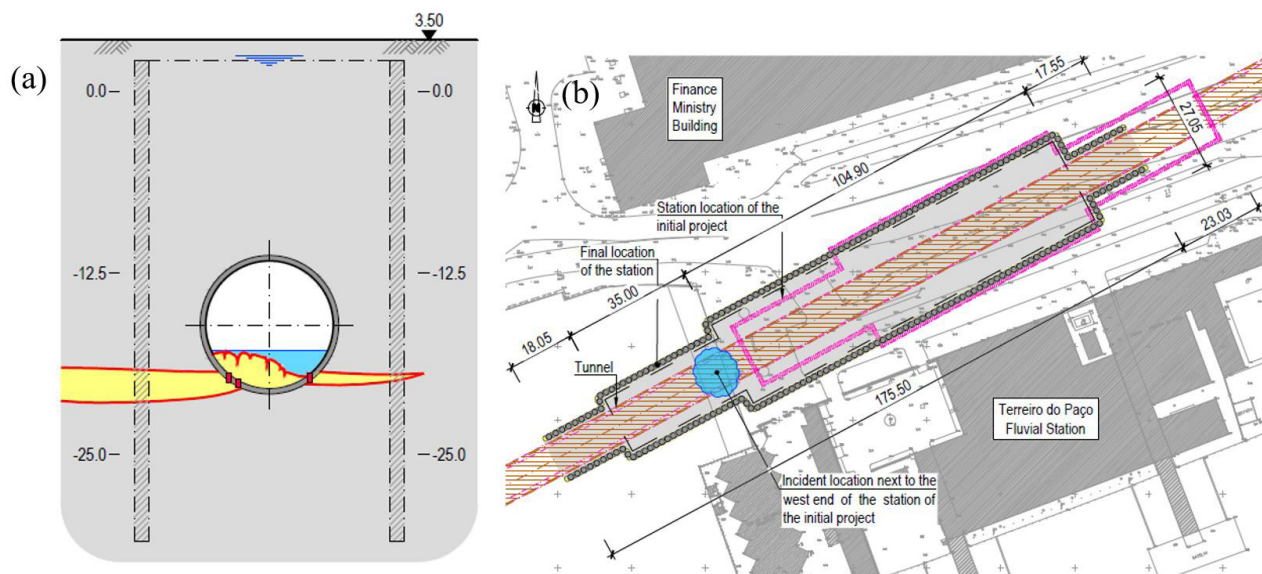

Figure 9. (a) Schematic section of the water and soil entrance into the tunnel (Ferconsult, 2012); (b) Location of the stations of the initial and final project and the accident area (Ferconsult & Metropolitano de Lisboa, 2011).

contact with the ground, since it was specified that these holes should have the length strictly necessary to cross the concrete lining and not perforate the cement grout injected during the construction of the tunnel. But it was impossible to prevent water from entering, as the thickness of the injection grout not enough to resist the pressure of the outside water. The design of the tunnel portals treatment was probably based on the assumption of the presence of low permeability soft clays and sandy-clays alluvial deposits with hydraulic behaviour controlled by the fine fraction. This assumption was not supported by the available geotechnical information and resulted in an unacceptable risk.

Clearly, very biased judgements were made by the entities involved in the design and execution, due to a lack of perception of the risks associated with the opening of the

holes. On the other hand, if the holes had been obturated immediately after drilling, there will be no or much fewer negative consequences. The information available at the time indicated the probability of the presence of clean and very permeable sands, but the contract documents did not include any specific references to this risk and to special precautions to avoid it, and no contingency means were mobilised to control the problem immediately.

2.3.6 Transfer of the station

During the tunnel reinforcement and stabilisation works, a new project was developed for the station, implemented in such a way that the incident area was inside it (Ferconsult & Metropolitano de Lisboa, 2001), as shown in Figure 9 b.

2.4 Presentation of the second project of the station

2.4.1 Design constraints

The design of the station was conditioned by the following aspects (Brito & Fernandes, 2006a, b):

- The excavation to be carried out was very deep, of around 25 m;
- The soils involved, to greater depths than the excavation, had very weak mechanical characteristics; they consisted of fills and soft alluvial deposits of the Tagus River, consisting of organic silty clays and soft sands, to a depth of 26 m, underlying very hard Miocene clay soils; the pressures to be balanced by the curtain were therefore very high;
- The groundwater level was very close to the surface of the terrain, being influenced by the tides;
- The soils interested in the excavation exhibited an extremely high complexity and variability;
- In the surroundings of the excavation there were old public buildings of exceptional patrimonial value, endowed with direct or semi-direct foundations in the embankments and alluvial deposits;
- As a result of the tunnel accident, very significant movements had taken place in the west area of the works, although practically stabilised in the start-up phase of the station construction, which had naturally

reduced the tolerance of the surrounding buildings to any further movements.

2.4.2 Final structure

In simplified terms, the structure of the station corresponds to a large reinforced concrete box, built from the surface, connected to the tunnel in the two portals, at a distance of about 140 m and with a width of 16 m in the narrow area and 24 m in the wide part. Figure 10 illustrates the cross-sections of the final internal structure of the station in both areas, the position of the tunnel and the surrounding soils. The top of the substratum occurs slightly below the base of the station bottom slab.

2.4.3 Peripheral curtain

Reinforced concrete and bentonite-cement secant piles with 1.50 m diameter were chosen for the peripheral curtain. Bentonite-cement piles 1.75 m axis spacing were previously executed. The reinforced concrete piles were then built, alternately with the first ones and partially sectioning them, also with a 1.75 m spacing. All piles penetrated at least 8 m into the Miocene substrate. Figure 11 presents the plan and the elevation of the peripheral curtain and Figure 12 shows the theoretical position of the piles and the lining wall.

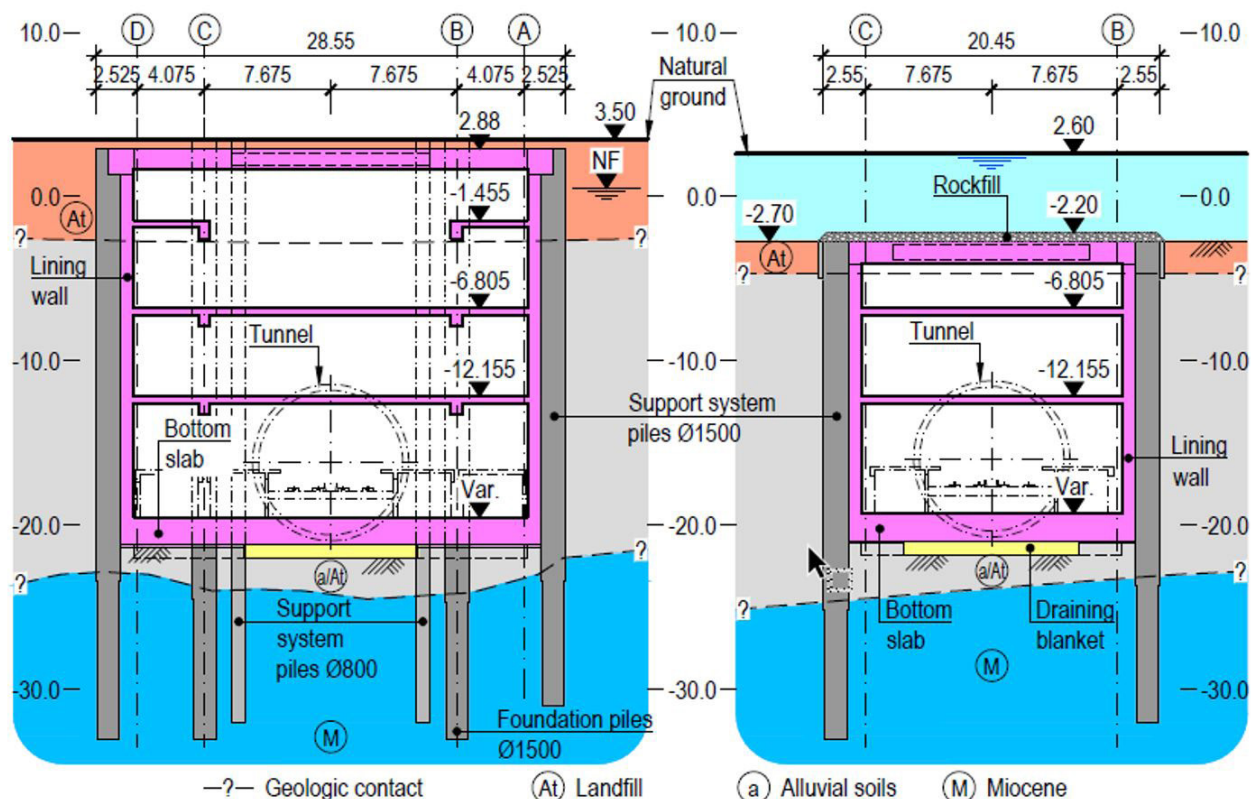

Figure 10. Cross-sections of the wide and narrow areas of the station (Brito & Fernandes, 2006a).

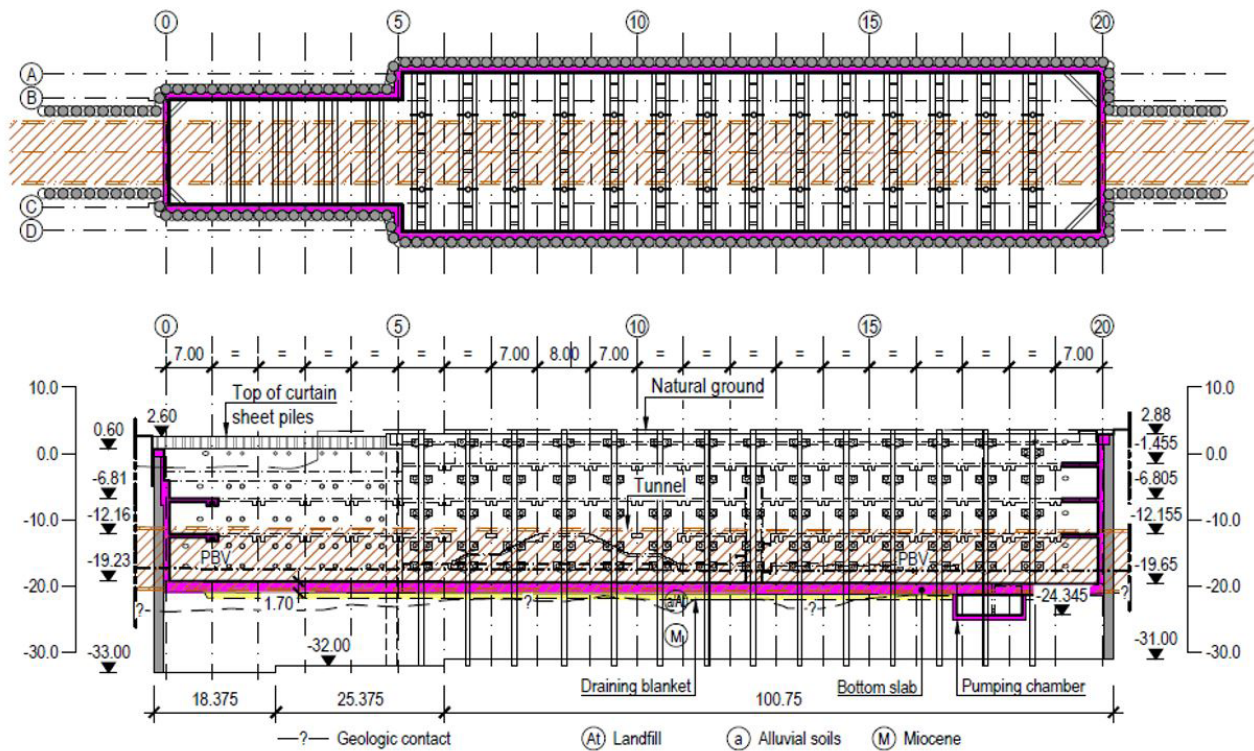

Figure 11. Plan and northern elevation of the peripheral curtain of secant piles and the shoring system (Brito & Fernandes, 2006a).

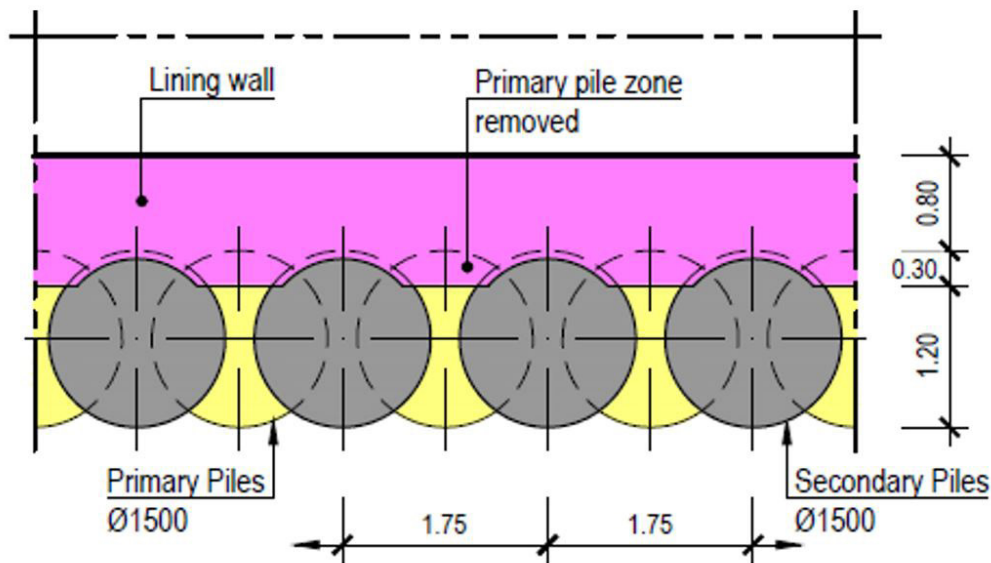

Figure 12. Plan of the theoretical position of the piles and the lining wall (Brito & Fernandes, 2006a).

The piles were connected by a reinforced concrete top beam, from which top-down method is used for constructing a reinforced concrete interior lining wall with a thickness of 0.80 m and structurally connected to the reinforced concrete piles (Figure 12). This wall was extended to the base of the excavation and connected there to the bottom slab (Figure 10).

The base of the curtain was between the elevations -31.00 m (north and east) and -33.00 m (south and west) and the maximum depth of the excavation was of 25 m (Figure 11).

For the temporary shoring system five levels of horizontal steel strut pairs were used, between the longitudinal faces (north and south) of the curtain, consisting of tubular

profiles of large diameter ($\phi 711$ mm) and thickness from 16 to 25 mm with an average horizontal spacing of 3.50 m. In the wide area of the station, the struts were provided with bracing elements in the vertical plane at two points supported on steel piles $\phi 800$ filled with concrete, embedded in the subsoil and installed prior to excavation. Figure 11 shows the position of the shoring in the northern wall elevation. Figure 13 shows the cross-sections of the shoring system in the wide and narrow areas of the station. The struts were strongly prestressed during the installation, with a uniform prestress load of 3500 kN per strut, introduced by 4 hydraulic jacks (Figure 14).

Figure 15 shows a view of the curtain and shoring system of the wide (left), and narrow areas (right), obtained from the Terreiro do Paço east tower.

Figure 16 shows the south and north walls of the station in the excavation phase below the 3rd strut level.

In the wide area of the station this temporary shoring system has been accompanied by a 3 m thick jet grouting slab, placed between the tunnel and the longitudinal curtains, with its median plane coinciding with the tunnel “equator” (Figures 13 and 17). This slab, combined with the tunnel itself and the corresponding filling material, provided a particularly suitable support to the curtain at a depth of about 18-21 m. This has significantly reduced the displacement

of the curtain compared to a solution method by using only conventional struts.

2.5 Execution phasing

Figure 18 shows the construction phases of the station wide area. Prior to the excavation, in addition to the peripheral curtain, piles similar to the curtain were built in the wide area of the station, for the foundation of the internal structure columns and the bottom slab. These piles were executed from the surface and concreted to the level foreseen for the bottom slab to which they were structurally connected. Steel piles filled with concrete were also installed for bracing the struts, which were later used, together with the former, as the foundation of the internal structure. Then, in the same wide area, the jet grouting slab was constructed between the tunnel and the longitudinal curtains.

The successive excavation phases (including the dismantling of everything involved in the system, such as the jet grouting slab, the lining and the filling of the tunnel) were articulated with the construction of the reinforced concrete lining, the installation and prestress of the shoring and the lowering of the groundwater level inside by means of deep shafts installed up to the substrate. Once the excavation bottom was reached and the drainage system was built, the

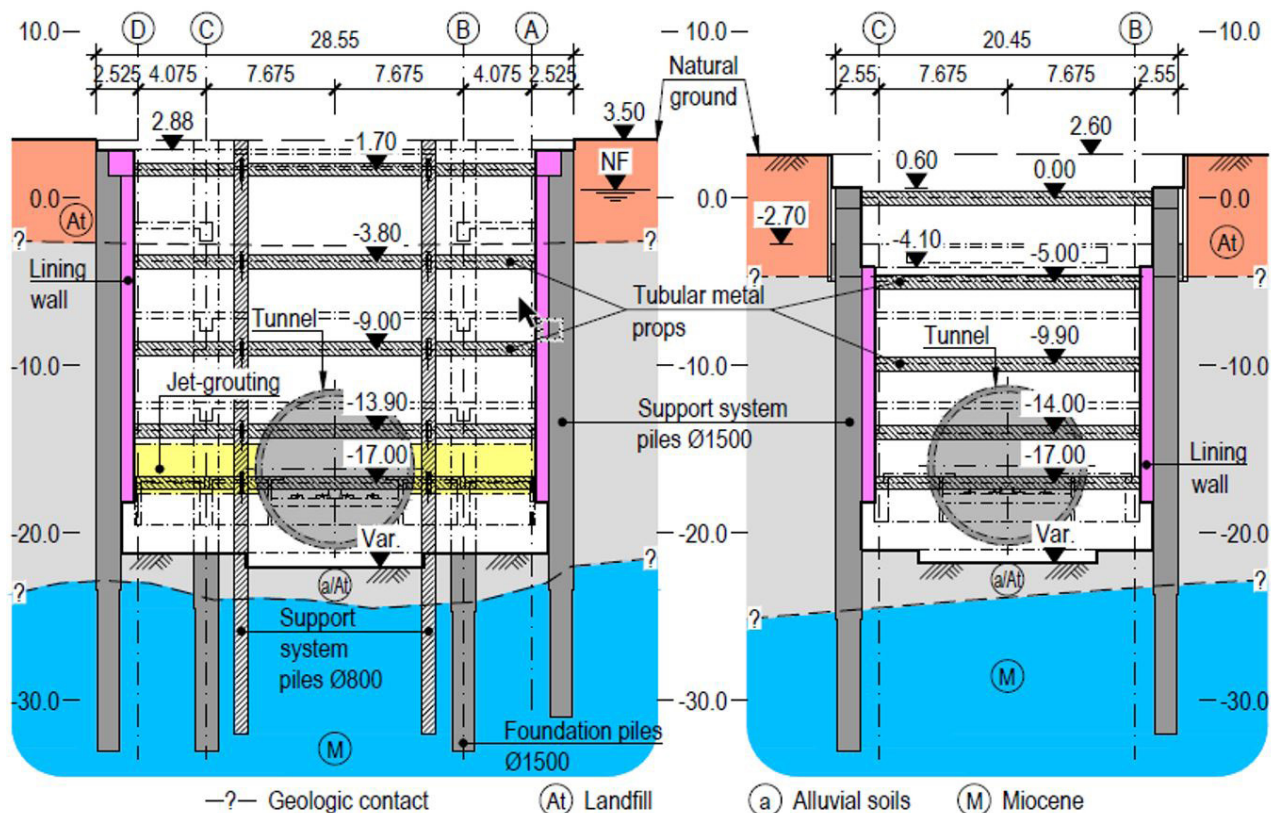

Figure 13. Cross sections of the wide and narrow areas of the station after completion of the last excavation phase (Brito & Fernandes, 2006a).

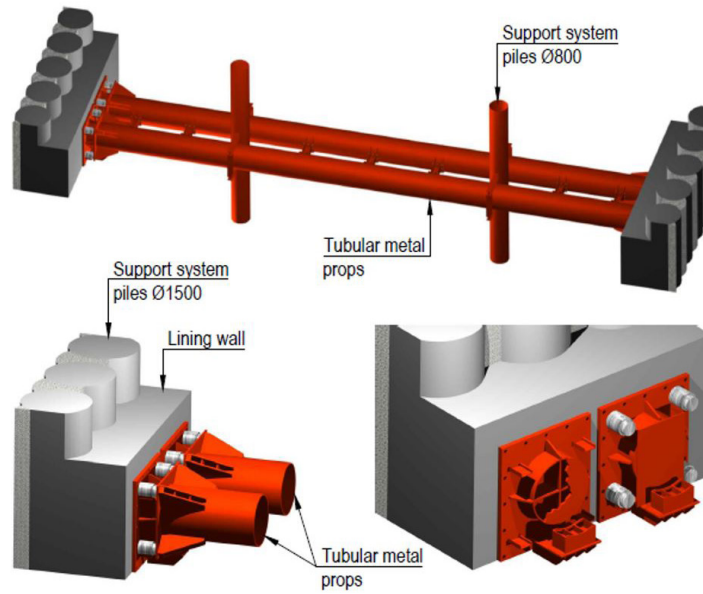

Figure 14. Struts system of the station wide area and the device for the application of prestress (Brito & Fernandes, 2006a).



Figure 15. View of the curtain and shoring system from the Terreiro do Paço east tower (Brito et al., 2016).



Figure 16. Excavation phase below the 3rd struts level on the south and north walls (Brito & Fernandes, 2006a).

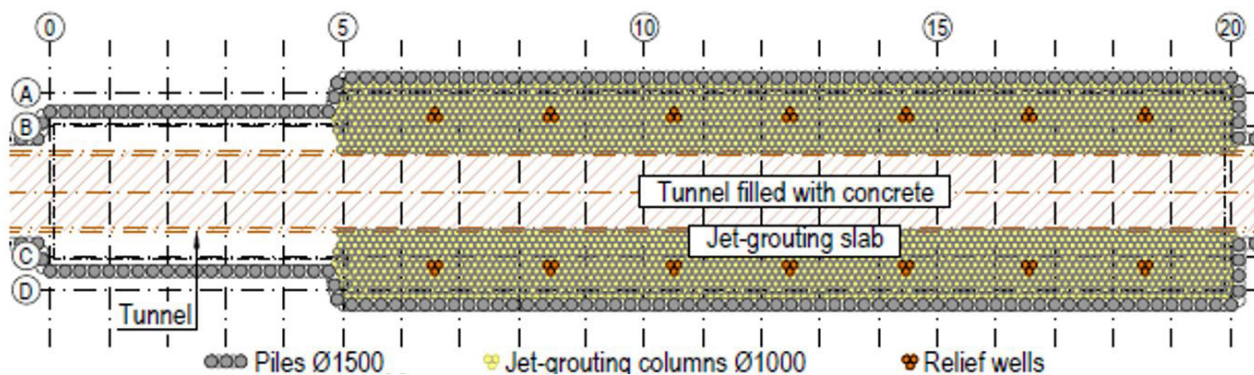

Figure 17. Plan of the jet grouting slab (Brito & Fernandes, 2006a).

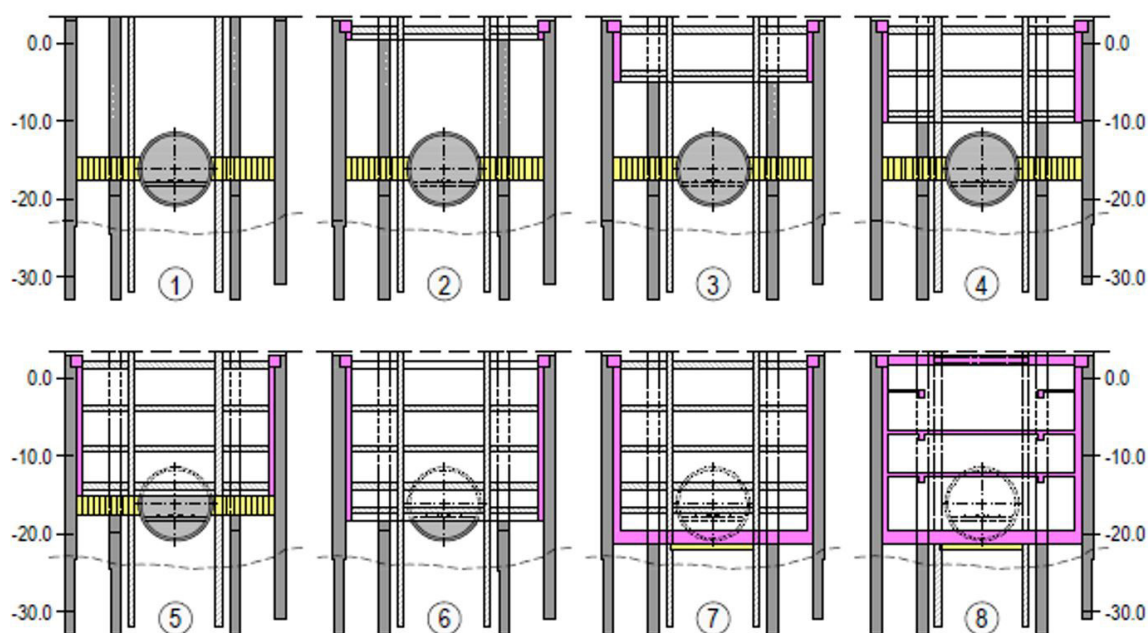

Figure 18. Representative phases of the construction phase of the wide area (eastern) of the station (Brito & Fernandes, 2006a).

bottom slab, the columns (existing only in the east area) and the successive slabs and beams of the final structure were executed from the bottom up, in articulation with the removal of the temporary shoring.

2.6 Portals

On the two extreme transversal walls of the station adjacent to the portals, the piles could not pass through the tunnel. It was then necessary to complement the pile curtain on these sites with a system which would allow the excavation to be carried out safely, as well as the construction of the final internal structure of the station, adequately connected to the tunnel lining. The extreme importance of the performance of such a system can be evaluated taking into account that the soft alluvial soils in contact with the clay substrate, located near the base of the tunnel, 25 m below the groundwater level, were at certain points made of clean sand.

As shown in Figures 19a and b, the solution consisted of surrounding the tunnel sections adjacent to the station with a mass of soil treated with jet grouting which would have to fulfil two essential conditions: be practically impermeable and also be resistant to water and soil pressures on its outer face. In order to meet these conditions, it was essential, on one hand, to ensure good penetration of the jet grouting mass into the Miocene substrate and, on the other hand, to make a good connection between itself, the tunnel lining and the station structure. To achieve this last requirement, the peripheral pile wall of the station was extended about 16 m beyond the plane of the portals, in order to confine the tunnel and the jet grouting, as can be seen in Figure 11.

Only vertical jet grouting columns were decided to be used, which meant, for the columns under the tunnel, that the lining of the tunnel would be crossed by drilling at two points, as shown in Figure 19b). This option was taken on

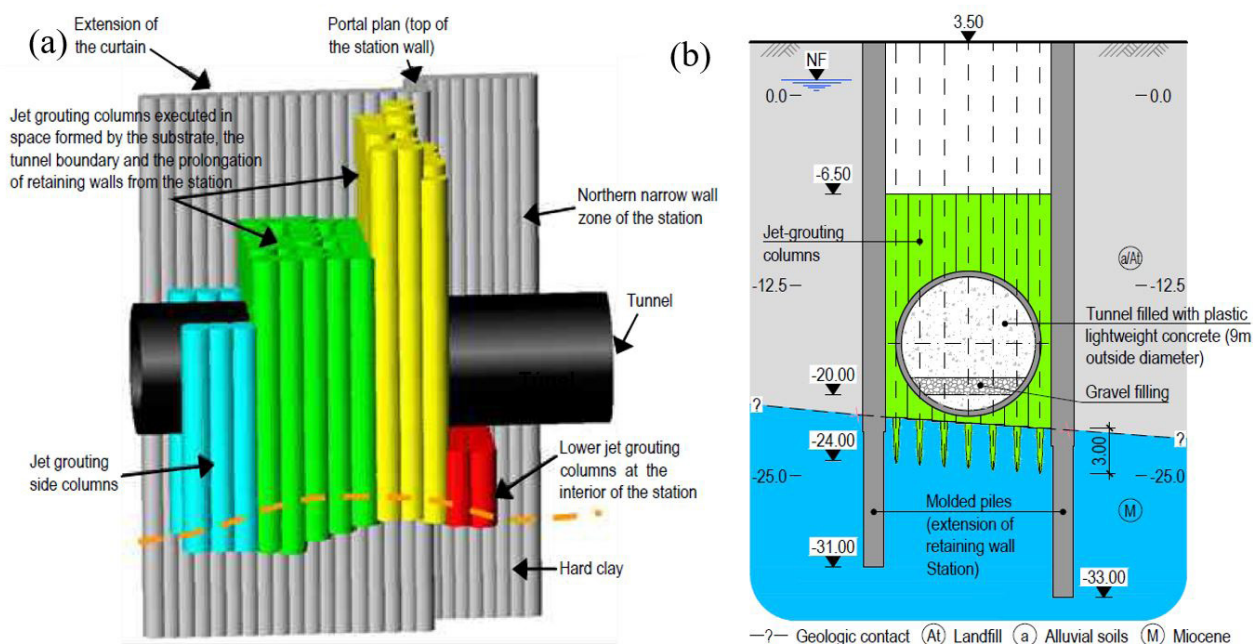

Figure 19. (a) 3D view of the jet grouting treatment on the west portal; (b) Cross section of the west portal plane, showing the area treated with jet grouting (Brito & Fernandes, 2006a).

the basis that the tunnel at these locations was filled with concrete and that there was no immediate adverse effect of these holes on the internal stability of the tunnel. In any case, an attempt has been made to minimise the number of holes so as not to weaken the concrete lining, in order to ensure the stability conditions of the tunnel in the phase of the concrete filling removal. For this purpose, large diameter jet grouting columns ($\varnothing > 2.0$ m) were used, executed with triple jet method (Candeias et al., 2005, Matos Fernandes et al., 2007).

2.7 Monitoring plan

The construction was monitored throughout the construction period by a very complete system of observation devices, whose transversal profile is shown in Figure 20. This system proved to be extremely useful in the critical phases of the station execution and in the sequence of incidents that occurred and in the subsequent outside treatment of the curtain.

2.8 Incidents during the final excavation phase

2.8.1 Location of the incidents and state of progress of the works at the time they occurred

In the final phase of the excavation two important incidents occurred, water and solid material entering through the curtain, at levels close to those at the base of the excavation. The first occurred on May 10, 2003, at the re-entrant corner of the north side coinciding with the axis

5, and the second on June 2, at the re-entrant corner of the south side coinciding with the axis 20 (Figure 11).

At the time of the first incident, in the wide area of the station, the excavation base was at approximately at the level -18.50 m (about 22.00 m deep) and the installation of the 5th level of struts was almost complete; the last excavation phase was therefore to be carried out in order to reach the level of -22.00 m corresponding to the maximum depth (25.50 m). In the narrow area, the 4th level of struts had already been installed and the excavation below it had been taken to about the level -20.00 m (to the base of the tunnel), about 2 m below the level foreseen in the designed construction phasing (level -18.20 m). This over-excavation of about 2 m was motivated by the need to better examine the tunnel concrete lining that was being removed, since it was in this area that the tunnel structure had suffered the most significant damages in the accident of June 2000.

On the other hand, at the time of the second incident, the excavation at corner zone where it occurred was completed, with ongoing preparatory work for the construction of the bottom slab, which was already concreted in the symmetrical corner on the north side.

2.8.2 Incident of May 10, 2003

2.8.2.1 Description of the incident and measures taken to control water and alluvial deposits inlet

The incident was manifested by the entry of water and the dragging of solid, silty-clayey and sandy material

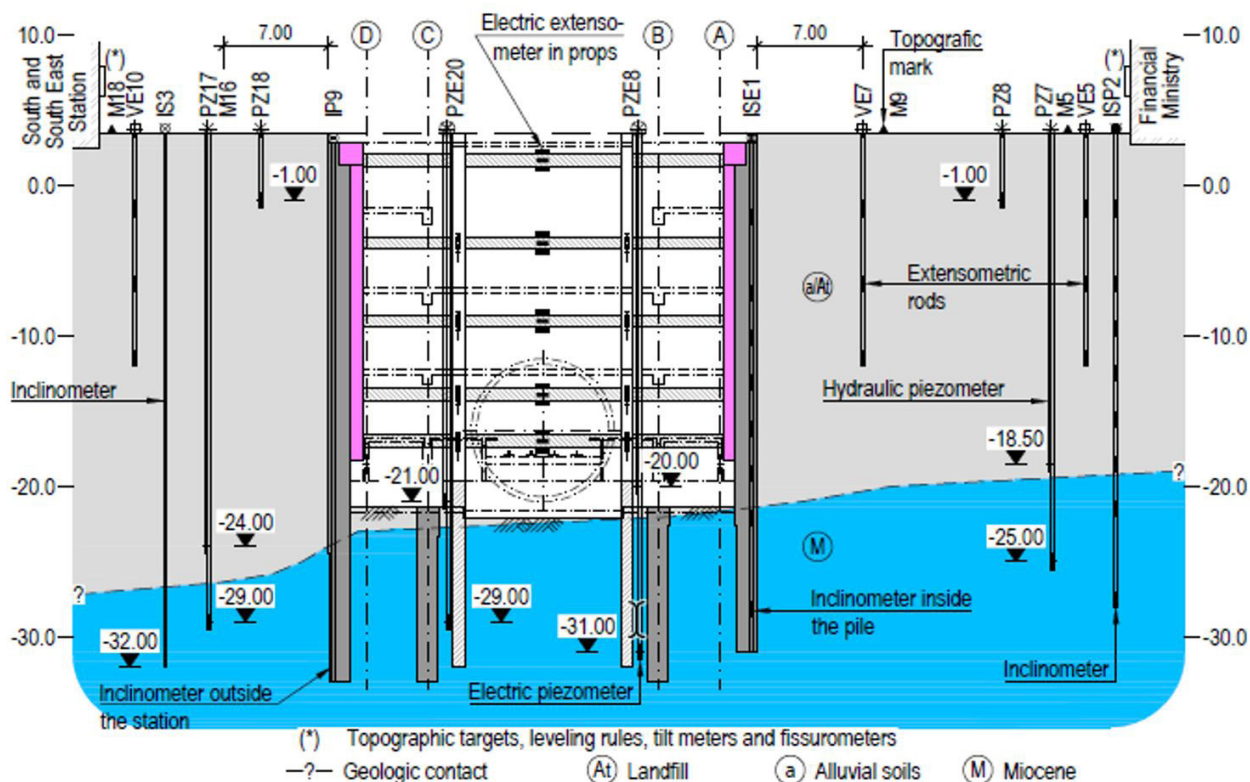

Figure 20. Typical cross-section of observation devices (Brito & Fernandes, 2006a).

in the re-entrant corner on the north side coinciding with the axis 5. At that time, the base of the excavation was at the level of the working platform foreseen for the installation of the 5th level of struts (between about the levels -18.00 m and -19.00 m) and the water inlet and drag of material occurred at approximately the level -19.00 m. At that level, outside the area adjacent to the curtain, the soils were constituted by sandy-clay alluvial deposits with a slightly thick passage of clean sandy alluvial deposits over the Miocene substrate. As can be seen in Figure 21a and b, the entry of water and alluvial soil into the excavation occurred more significantly when the soil between the EP63 and EP65 primary piles was excavated. This terrain, during the excavation with the backhoe bucket and the progressive inflow of water from outside, collapsed by “blocks” of sandy-clay alluvial deposits, clearly showing the distance between those primary piles. Figure 21 a show the opening filled with alluvial deposits, and it is not possible to see the secondary corner pile (ES65), which, if it were in its correct position, would be visible. Figure 21b highlights this fact, since it was possible to insert a wooden beam to a certain depth (at least 0.50 m) beyond the visible soils face between piles.

In the emergency operations carried out immediately in order to control the entry of water and alluvial soils, sand bags were first placed, already available on site for the case of an eventual emergency during the execution of the waterproofing plugs of the tunnel portals. It was progressively necessary to place cement bags, concrete and geotextile blanket until

it formed a plug in a conical shape against the corner of the curtain and with the top at the level of the base of the lining wall (level of -15.10 m) as shown in Figure 22. In the opening between the piles a tube was introduced to capture part of the tributary flow to the corner.

2.8.2.2 Immediate consequences outside the curtain

After the incident, the following events were immediately registered outside the curtain:

- Settlements and cracks in the surface in the vicinity of north corner 5 in front of the tower of the Finance Ministry building; these settlements evolved rapidly and covered an area of about 500 m² with visible subsidence and radiating from the point of entry of water and material into the excavation; the settlements tended to stabilise quickly after the entry of water and alluvial soils was eliminated;
- The maximum settlement registered on the surface was 28 mm on a mark located 25 m from corner 5; a settlement of 5 mm was registered in the tower;
- Two piezometers, with the chambers in the alluvial sand layer at levels -18.50 m and -18.00 m, (at distances from the corner concerned of 8 m and 40 m, respectively) showed a drastic reduction in pressure of 12 m and 7 m respectively; the water pressures returned to normal values, when the entry of water started to be controlled;

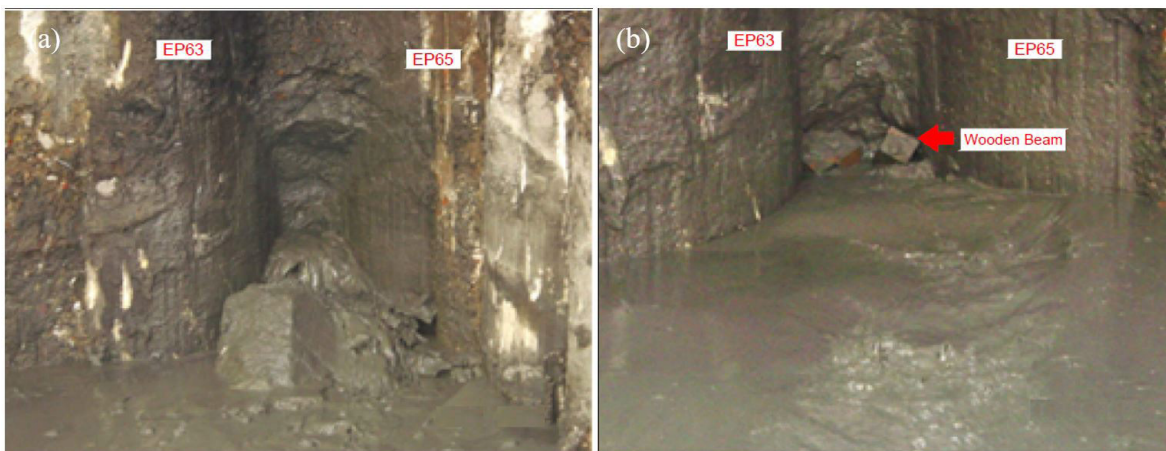

Figure 21. (a) Initial phase of water inflow and dragging of sandy-muddy alluvial deposits in the north corner 5; (b) Most significant water inflow and alluvial deposits shortly after the start of the incident.



Figure 22. (a) Plug of sand bags, cement and concrete bags, about 3 m high; (b) Retaining piles from the narrow area on the north side between axes 3 and 5 after excavation up to the level -20.00 m, plug of sand bags and the underside of the lining wall at the level -18.20 m.

- An inclinometer, located about 5 m from north corner 5, has recorded significant displacements to the base of the alluvial deposits (at about 25 m deep) with a maximum displacement of the order of 30 mm at 16 m deep;
- The effect of the incident was felt only on the north side of the curtain and up to more than 100 m away from corner 5 in the piezometers, surface marks and extensometric rods installed in the alluvial deposits.

The piezometers installed on the Miocene substrate inside and outside the curtain, did not register any variation in the water level and in the piles, no cracks or anomalies in the lining wall and in the top beam indicating settlements of the retaining curtain, proving that the Miocene formations were not affected.

2.8.2.3 Action that stopped solid material to enter to the curtain inside

The action that succeeded in preventing solid material from entering the excavation the day after the incident was

the placing of the plug and the injection of cement grout into holes adjacent to the entry point, executed outside the curtain. The flow of clean water has dropped to a relatively low amount (about 24 m³/day). The flow rate was later reduced when the curtain was treated at the back. It was about 3 m³/day when the concreting of the bottom slab was completed. Then it was diverted to the blanket drain with connection to the definitive pumping well of the station.

2.8.2.4 Survey of the piles position at north corner 5

Following the completion of the waterproofing treatment in north corner 5 (as described in chapter 2.9.6), an inspection shaft was opened manually between approximately the levels 15.30 m and -18.00 m. The survey of the positioning of the piles was not entirely conclusive in relation to the position of the ES65 secondary corner pile as, for safety reasons, it was not possible to dig the shaft much deeper and to remove, between piles, part of the constituent materials of the plug. However, with the information available, namely the position inferred from Figure 21, it was possible to define the most

likely position of the ES65 pile. Figure 23 shows the survey of the position of the retaining piles at corner 5, here the deviation of the ES65 pile from the theoretical position was of about 0.75 m at level -18.00 m, which corresponds to an inclination of 1/28.

At the bottom of the shaft, one could see the inflow of water that was rising and being directed to the intake pipe. This water inflow was concentrated in the corner between the EP65 and ES65 piles. As Figure 23 shows, the area where the water inflow was observed corresponded exactly to the area of lack of overlap between the EP65 and ES65 piles.

2.8.2.5 Complementary aspects

In the corner concerned, as well as in the symmetrical corner 5 (south), small water transfers (without solid material) have been taking place since the first excavation phases. This was manifested in particular by the appearance of water in contact between the base of the back of the lining wall and the piles curtain. These transfers were reduced or disappeared by means of cement injections between the two walls (the lining wall and the pile wall), carried out before the incident.

The sandy soils dragged inside the station had a similarity, due to their aspect and granulometry, with the alluvial sands overlying the Miocene substrate that were excavated inside the excavation. The dragged sands had also small fragments of wood, bricks and coal, indicating that they came from alluvial deposits.

2.8.2.6 Conclusion on the cause of the incident

The incident was caused by an opening in the piles curtain, in particular in the contact of the EP65 primary pile with the ES65 secondary pile, where the influx of water and alluvial soils was triggered when the excavation reached approximately the level -18.00 m. This opening was caused by a deviation of the axis of the ES65 pile, located at the

corner of the curtain, resulting from an inclination proven to be greater than 1/30 with respect to its theoretical axis, much higher than the maximum allowable inclination of 1/100, thus not guaranteeing water tightness.

2.8.3 Incident of June 2, 2003

The second incident was very similar but less serious than the first, with dragging water and soil into the excavation. The consequences on the outside were similar but the maximum settlement did not exceed 5 mm.

Following the second incident, it was decided to stop the work, due to the uncertain position of the piles, until the survey of its position and the analysis of the possible mitigating solutions be implemented to guarantee the tightness of the curtain.

2.9 Measures adopted to continue the work in safe conditions

2.9.1 Assessment of risk scenarios

Some entities involved in the work, namely the contractor consortium and the supervision team, developed some biased judgments attributing the origin of the incidents to the existence of the permeable layer of sand with artesianism, interspersed in the Miocene clays (Figure 6).

Thus, following the second incident, it was decided that, in addition to stop the excavation, curtain works and the execution of the bottom slab, a review of risk scenarios and the precautionary and reinforcement measures to be adopted should also be made.

The following scenarios were analysed:

- Hydraulic lifting (“heaving”) from the bottom of the excavation;

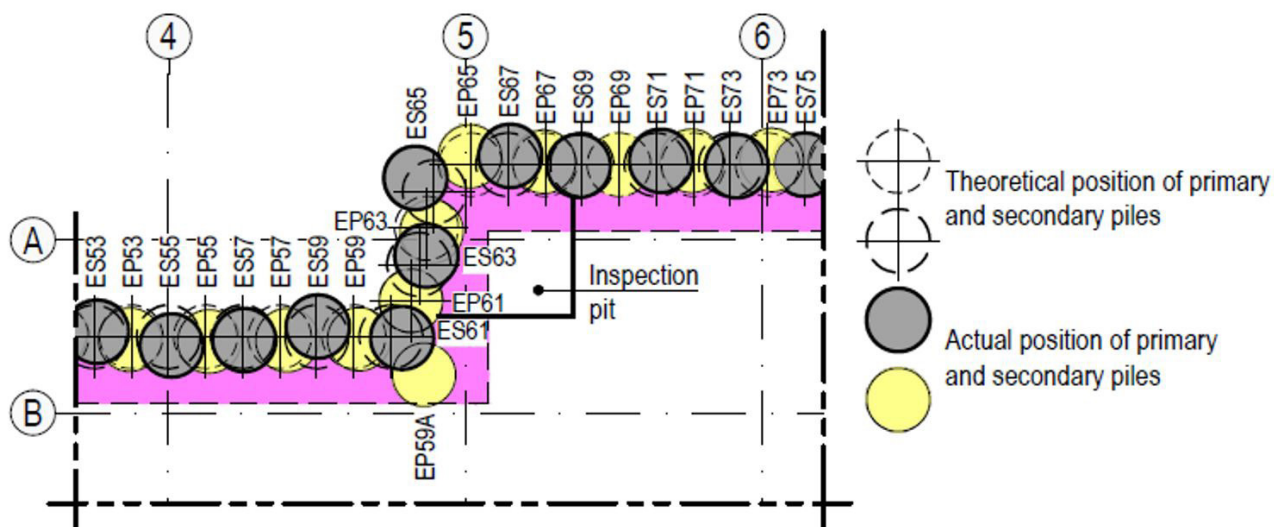

Figure 23. Plan at level -18:00 from survey of the piles position at north corner 5.

- Erosion in the contact between curtain / ground (“roofing”);
- Internal erosion of the soils (“piping”);
- Water inflows due to poor overlap between primary and secondary piles;
- Water inflows due to lack of integrity of the primary piles;
- Water inflows due to the lack of integrity of the secondary piles;
- Water inflows through openings in the contact between piles, in the last stages of excavation;
- Hydraulic uplift of Miocene clays in the west part of the station due to the artesianism of the Miocene of compact sandy silt levels closest to the bottom of the excavation (around -33.00 m);
- Water inflows, in the west portal, resulting from eventual deficiencies in the surrounding treatment by jet-grouting.

The survey of the position of the piles allowed to identify as a cause of the important inflows of water to excavation with transport of solid material, the deviations of the piles in relation to their theoretical verticality, deviations that reduced or even cancelled the overlaps between primary and secondary piles, in the body of the curtain, at the top of the Miocene or just below, especially at deeper levels of excavation. In fact, the analysis of these deviations showed that, in many cases, the specified vertical tolerance of 1/100 was substantially exceeded. These piles deviations were naturally more significant at lower levels, not guaranteeing a minimal overlap between primary and secondary piles. However, no inflow of water from the tip of the piles were detected inside the excavation perimeter, confirming very low permeability of the Miocene and its great resistance to “roofing” phenomena.

It should also be noted that, although the flow rates affluent to the bottom of the excavation could be of varied origins, namely of the Miocene compact sandy silt levels closer to the bottom of the excavation, this situation was investigated with tests that revealed low coefficients of permeability

and inexistence of artesianism that would be critical to the local stability of the bottom of the excavation. In addition, all fine levels of silts and silty clays, more permeable than Miocene clays, were intercepted by the relief holes inside the excavated enclosure, and it should be noted that the flow rate in the relief wells was always modest.

As additional emergency precautionary measures, to be used only in the event of a new incident, it was foreseen:

- The maintenance on site of a stock of sand and cement bags, geotextile and gravel for the formation of a plug, similar to those carried out in the corners of the two incidents that occurred;
- The realization of a network of pumping holes outside to relieve water pressure in the alluvial sands layer.

2.9.2 Holes for lowering the water table in holes outside the containment

Pumping holes were made on the periphery of the curtain down to the top of the substratum, with the location shown in Fig. 24. These holes, equipped at the base with a pump ready to operate, were intended to reduce outside water pressures at the level of the alluvial base, in case a new incident, similar to the previous ones, would occur in the last excavation phase, necessary for the concreting of the bottom slab. This system proved to be quite effective in the water lowering tests carried out. This emergency measure was not necessary.

2.9.3 Interruption of work and survey of the position of the piles

Following the first incident, the design team requested a survey of the position of the primary and secondary piles. However, given the practical difficulty of accessing the primary piles without the excavation of the surrounding soils, this survey was not carried out. Following the occurrence of the second incident, the designer proceeded to a thorough inspection of some primary piles on the south wall on the

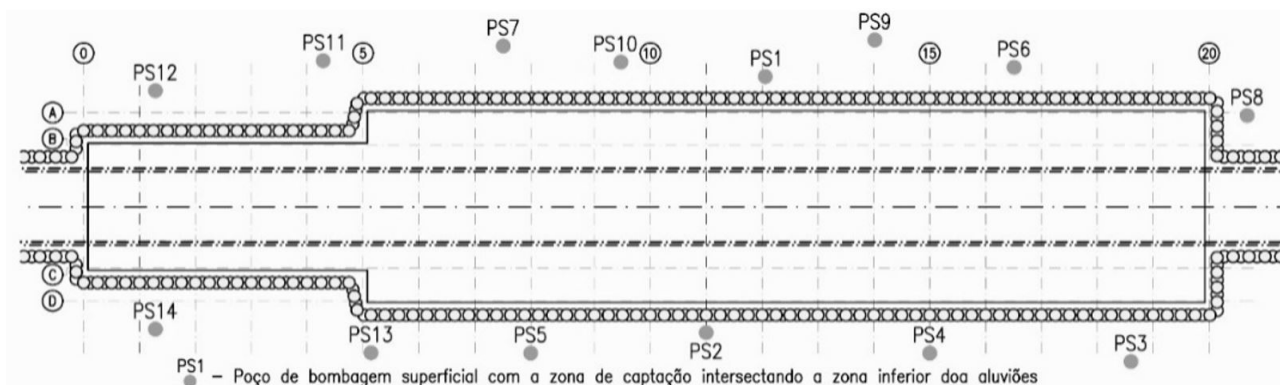

Figure 24. Location of pumping holes in the alluvium outside the station (Brito & Fernandes, 2006a).

east side between EP158 and EP174, located between axes 16 and 18, and on the north east side piles. After this inspection, the design team considered essential to carry out the survey of the position of all the piles at the elevation at which the excavation was located (elevation -18.70 m in a large part of the wide area at the date of the second incident), in order to identify the eventual existence of critical areas of the pile curtain.

With the occurrence of the two incidents, it was found that the lack of verticality of the piles could result, with the works development, in similar or even more serious incidents than the ones that occurred and with unforeseeable consequences. The most serious situation of a rupture that would be difficult to control could result in significant damage to the tower and to the other buildings.

On the other hand, in the narrow area it was decided to fill the zone to the level -16.00 m (about 4 m), where the lining wall was not yet been built to install the 5th level of struts, and where, as mentioned, there was executed an over-excavation of about 2 m.

2.9.4 Analysis of the results of the survey of the position of piles

The analysis of the pile survey, allowed to verify the existence of:

- Zones, more or less located, where some of the piles had slopes of about 1/50, resulting in a very reduced thickness of the primary piles (as they were removed with the execution of the secondary piles), so localized ruptures of primary piles could not be excluded; this situation resulted from the fact that the piles were inclined in the transversal direction of

the station with the primary ones inclined inwards and the secondary ones towards the outside;

- Zones where the resistant thickness of the primary piles was insufficient due to a significant overlap with the secondary piles, where the inclinations of the piles were also about 1/50;
- Zones where the distance from the adjoining primary piles was high, therefore it was not possible to exclude the existence of openings between piles as the excavation proceeds; in these zones the situation mentioned resulted from the fact that the secondary piles incline in opposite directions, predominantly in the longitudinal direction of the station, with an inclination between 1/40 and 1/70.

As an example of the lack of verticality of the piles Figure 25 a is presented. This figure was obtained at the time of opening the inspection ditch for observation of the piles, before the general excavation for the execution of the bottom slab. It is observed the great deviation of the secondary piles in relation to the primary piles, well evidenced by the distance to the posterior line of reinforcement steel of the lining wall, conducting to a great concrete thickness of the lining wall. It should be noted that, if the execution of the piles had respected the specified tolerances, at the elevation at which the lining wall was located (-18.20 m), the maximum deviation from the vertical should be about 0.25 m in relation to the face back of the lining wall. As an example of the distance between primary and secondary piles, Figure 25 b is shown.

2.9.5 Curtain design considerations

Regarding the openings between piles, resulting from the deviation of piles from their theoretical axis of implantation



Figure 25. (a) Curtain piles at the level of the bottom slab; (b) Very significant spacing between primary bentonite-cement piles, in the foreground, and secondary reinforced concrete piles, in the background.

beyond the limit defined in the technical specifications, the design team considered it opportune to make the following considerations in the report delivered to the owner, following the first incident:

- During the design phase, several work meetings were held involving the project team, the contractor and the owner's team and consultants;
- The type of containment curtain adopted in the design phase - reinforced concrete and bentonite cement piles 1.5 m in diameter curtain - resulted from the suggestion of the contracting consortium, welcomed by the remaining stakeholders in the process, as an alternative to a conventional curtain of reinforced concrete slurry walls;
- The curtain of secant piles appeared as more appropriate for a ground that, on the one hand, could present large buried obstacles (wooden piles, masonry of old quay walls, etc.), offering, on the other hand, better guarantees of stability when crossing low-resistance soft clay layers; in addition, it is essential to underline that the joints between piles offered better watertight conditions than those of a slurry wall;
- It is also worth noting that in the design phase the modulation initially proposed by the contractor consortium, piles with a diameter of 1.50 m with 2.00 m axis spacing, was reduced for piles of the same diameter with 1.75 m axis spacing; with this reduction, implying that in the middle plane of the wall the primary bentonite-cement piles were only 0.25 m between the reinforced concrete piles, an attempt was made to increase the tightness conditions of the curtain (this change resulted from the fact that the execution equipment of the piles allow to ensure only a tolerance of 1/100 instead of the tolerance of 1/200 in relation to the verticality of the piles specified by the design team); the tolerance adopted of 1/100 corresponded to a maximum theoretical spacing of

the position of each pile of only 0.25 m, at the -22.00 m level of the excavation bottom;

- Thus, the designed curtain corresponded to a more conservative option than a conventional curtain, allowing the construction experience to ensure, despite the verified incidents, that the option taken was appropriate.

2.9.6 Treatment with multiple injections of the ground in critical areas outside the curtain

Taking in account the survey results concerning the piles position, the solution that came to be adopted to guarantee the necessary safety conditions for the advance of the excavation and the execution of the bottom slab, was the treatment of the ground at the back of the curtain with multiple injections of grout in manchette tubes with 0.50 m spaced holes. The injections were repeated in all the manchette tubes the number of times necessary to reach pre-established limit values for injection pressure and cement grout absorption.

As shown in Figure 26 injection treatment involved:

- All corners (re-entrant or protruding) of the station, with the exception of the north corner coinciding with axis 20, on which the bottom slab was already built;
- The areas outside the corners where the most significant deviations were detected;
- All the narrow area of the station, due to the difficulty in carrying out a rigorous survey and in safe conditions of the position of the piles.

Depending on the situation assessed, two types of injection hole patterns were defined, with two and three rows of holes, in the locations shown in Figure 26 and 27. The injection length was defined in the upper zone with 2 m overlap with respect to the lining wall already made and in the lower zone with a penetration of 4 m or 6 m in the Miocene substrate due to the smaller or greater spacing of the piles (Figure 27 c).

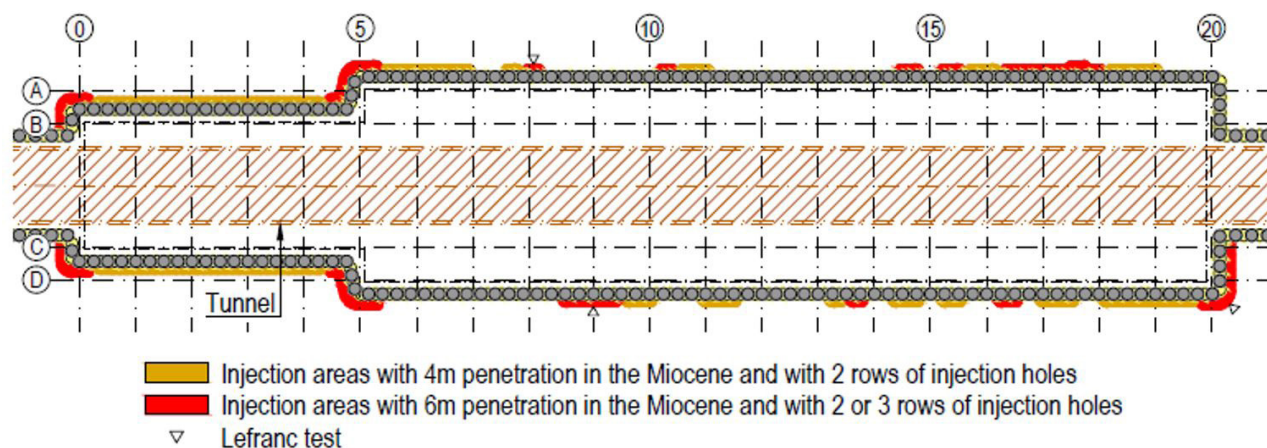

Figure 26. Location of the injected areas outside curtain (Brito & Fernandes, 2006a).

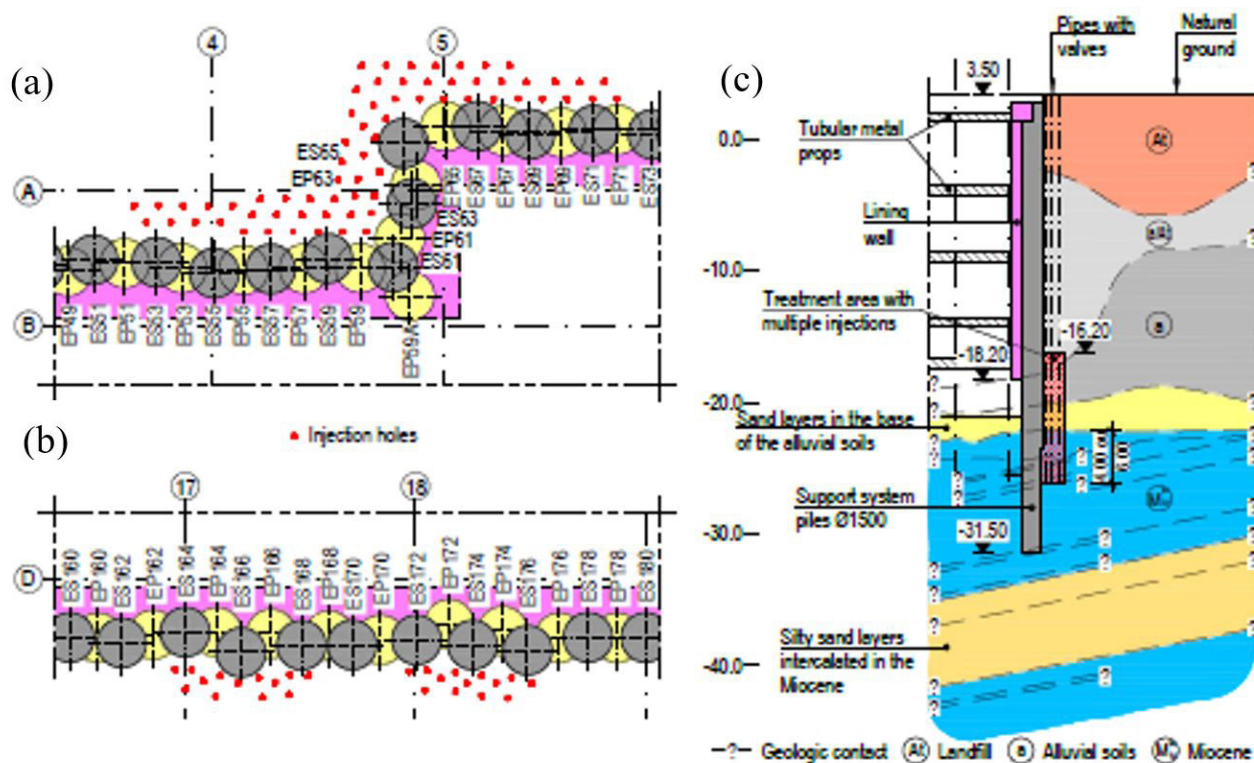

Figure 27. (a) Plan of injection holes in continuous meshes with two and three rows in the north wall in the vicinity of axis 5; (b) Plan of injection holes in meshes located with two rows in the south wall in the vicinity of axes 17 and 18; (c) Vertical cross section in the north corner 5 with indication of the injection holes with manchette tubes and the area treated with multiple injections (Brito & Fernandes, 2006a).

In Figure 28 a one of the 3-row mesh of injection holes can be seen. As shown in Figure 28 b, during the execution of the injections, some grouting entrances were registered inside the station through openings in the curtain.

The efficiency of the treatment was evaluated by means of Lefranc tests, performed before and after the treatment by injections, as well as by examining the samples collected in the boreholes necessary to carry out these same tests. Although it was not completely effective, as it did not eliminate the flow affluent to the interior of the station, the treatment by multiple injections proved to be very efficient. This efficiency was attested by the fact that, during the period in which the waterproofing injections took place in the narrow area of the station, there was a progressive decrease in the influx of water to the alluvium overlying the Miocene substrate inside the station, with the progressive reduction of the flow rate pumped into the relief wells installed there.

2.9.7 Impact of the injection treatment at the back of the curtain

The impact of treatment by injections on the back of the curtain was significant, and was basically reflected in the following:

- Increased forces in the support system, in particular at two lower levels (4th and 5th levels) closest to the injected areas;
- Modification of the type of movement of the curtain, which in the upper zone moved against the supported soils;
- Lifting of a few millimetres from the curtain, registered in most superficial marks.

It should be noted that, in the narrow zone, the forces on some struts, particularly those on the 4th level, reached very high values, close to alarming levels. Those struts, before the injections, already had considerable forces installed, as a result of the over-excavation mentioned above. As the injections further increased those forces, it was necessary to introduce another adjustment to the constructive phasing initially envisaged in that area. This adjustment essentially consisted of reinforcing the 4th level with two more provisional struts and the advancing with the construction of some beams of the final structure.

2.10 Lessons learned

Flaws that lead to the occurrence of the incidents have resulted from the deficiencies in the execution of the piles, as the verticality tolerance of 1/100 was not obeyed. These



Figure 28. (a) Implantation of three rows of injection holes in the south wall in the vicinity of axis 9; (b) Injection cement grout from the outside of the curtain affluent to the interior near the corner 5 south.

flaws would have been avoided if an effective control of the verticality of the piles have taken place, either during the execution of the piles, or during the subsequent excavation phases with the observation of the respective position, which would have been allowed to take the mandatory provisions in time to avoid the incidents. This situation can be attributed to a judgmental bias that may have resulted from the excessive trust that was placed in the contractor consortium.

The failure was worsened in the re-entrant corners, since here there was a tendency for corner piles to move away from adjacent piles located in the two perpendicular alignments. In the four re-entrant corners, this tendency could have been avoided if four additional piles had been executed. It should be noted that the contractor consortium carried out additional piles at the two protruding corners of the transition zone between the wide and narrow areas of the station, in order to avoid deviation of the corner piles to the interior side of the station, as can be seen in Figure 23. For reflection, we may ask if the contractor consortium should not have proposed the execution of these additional piles, or if this should have been anticipated in the design phase.

In view of the occurrence of incidents, it is also legitimate to ask, if the use of concrete slurry walls would not have been more convenient, since, with the execution of L-corner panels, the problem of the corners would not have existed and the verticality control during the execution would have been more effective due to the characteristics of the slurry wall equipment more scaled up to that control. If these were the only conditioning factors for the choice of the solution, the slurry wall solution would probably have been adopted. However, the expected presence of old foundations of large dimensions in the fill and soft clay layers with low-resistance, made the pile solution more appropriate, as mentioned in chapter 2.9.5.

During design and execution there was intervention of expert judgement in several areas. It should be noted that the project was not revised by an independent entity.

3. Final considerations

Engineering judgment has always played an important role in geotechnical engineering. Before the advent of modern computers, projects were developed essentially based on the experience acquired in previous similar works. Currently, where design and analysis are assisted by computer, engineering judgment remains, or is increasingly indispensable for successful engineering, since geotechnical problems cannot yet be solved even by advanced numerical analysis without the introduction of geological conditions and geotechnical parameters that seek to bring the complex reality closer. On the other hand, the results of the computational analyses also have to be judged to be accepted or rejected, based on their plausibility. No doubt that what can be calculated improves judgment, allows to make better judgments and achieve better engineering solutions.

The development of geotechnical engineering and the increased complexity of geotechnical works requires increasingly the need to deepen the judgments. Aspects of geotechnical engineering which are not yet, and possibly never will be, subject to theoretical analysis, will require much more judgment. It must therefore be cultivated, recognized and used, which will surely render a progressive improvement in the safety of geotechnical works.

Acknowledgements

The author would like to express his gratitude to the Geotechnicians Association of Former Students from Universidade Nova de Lisboa (AGAA-UNL) and to the Portuguese Geotechnical Society (SPG) for the honourable distinction to present this Manuel Rocha Lecture. The author is especially grateful to Prof. António Mineiro, an inspiring figure at the beginning of his geotechnical career and with whom he learned to make good judgments and to develop critical thinking in geotechnical engineering and also to

thank to all colleagues with whom he worked at Hidrotécnica Portuguesa, Cenor and TPF companies, the spirit of team that has always chaired in all moments of fruitful debate and difficult decisions taken in the design and execution phases of many geotechnical works.

The author also thanks the great involvement of Metropolitano de Lisboa, Ferconsult and Metropaço (Teixeira Duarte, OPCA and Mota-Engil), in the most difficult moments of the station's execution and other entities and consultants, especially LNEC and Prof.^s António Mineiro and Maranha das Neves, also stressing the great dedication and commitment of the vast team of Cenor (now TPF) employees in participating in the project and monitoring the work execution, with emphasis on Eng.^{os} Fortes Monteiro, Miguel Albergaria and Alfredo Nunes and Dr. Sérgio Rosa and the essential participation of Prof.^s Manuel Matos Fernandes, António Silva Cardoso and Jorge Almeida e Sousa, in the conception and design of the station which was decisive for the success of this work.

Declaration of interest

The author declare that he has no competing financial interests or personal relationships that could have appeared to influence the work reported in this paper.

References

- Baecher, G.B., & Christian, J.T. (2003). *Reliability and statistics in geotechnical engineering* (618 p.). Wiley.
- Bandura, A. (1986). *Social foundations of thought & action, a social cognitive theory*. Prentice Hall.
- Brito, J. A. M., Fernandes, M. M., Monteiro, R. F. & Cardoso, A. S. (2016). Rehabilitation of soils and foundations. Terreiro do Paço Lisbon metro station. *Revista Construção Magazine*, 73, 10-17. (in Portuguese).
- Brito, J.M., & Fernandes, M.M. (2006a). Terreiro do Paço Lisbon metro station. Design, construction and observation (PPT presentation). In *X Congresso Nacional de Geotecnia*. Lisboa: SPG (in Portuguese).
- Brito, J.M., & Fernandes, M.M. (2006b). Terreiro do Paço Lisbon metro station. Conception, design forecast and performance. In *III Congresso Luso-Brasileiro* (Vol. 1, pp. 21-42). Curitiba. (in Portuguese).
- Brunswik, E. (1952). *The conceptual framework of psychology. International encyclopedia of unified science* (Vol. 1, No. 10). Chicago: The University of Chicago Press.
- Candeias, M.A.S., Brito, J.A.M., Fernandes, M.M., & Lopes, P.G. (2005). Terreiro do Paço Metro Station – A jet grouting solution to link the pre-existing tunnel to the cut-and-cover excavation. In *Proceedings of the 6th International Conference Ground Improvement Techniques* (14 p.). Singapore: CI-Premier.
- Dunncliff, J., & Deere, D.U. (Eds.). (1984). *Judgment in geotechnical engineering, The professional legacy of Ralph B. Peck* (332 p.). John Wiley.
- Dunncliff, J., & Nancy, P.Y. (Eds.). (2006). *Ralph B. Peck. Educator and engineer. The essence of the man*. BTech Publishers Ltd.
- Ferconsult, & Metropolitano de Lisboa. (2001). *Description of 2000 incident and details of the initial project of the new Terreiro do Paço Lisbon metro station*. Ferconsult & Metropolitano de Lisboa. Internal document. (in Portuguese).
- Ferconsult. (2002). *Terreiro do Paço Lisbon metro station – general project*. Ferconsult. Internal document. (in Portuguese).
- Hammond, K.R. (1996). *Human judgment and social policy: irreducible uncertainty, inevitable error, unavoidable injustice* (448 p.). Oxford University Press.
- Lambe, T.W., & Whitman, R.V. (1969). *Soil mechanics* (576 p.). John Wiley & Sons, Inc.
- Margolis, H. (1987). *Patterns, thinking, and cognition: a theory of judgment* (332 p.). University of Chicago Press.
- Marr, W.A. (2006). Geotechnical Engineering and Judgment in the Information Age. In *Proc. Geo-Congress 2006* (Vol. 1, pp. 52-68). Reston: ASCE.
- Marr, W.A. (2019). Geotechnical judgment and risk. H. Bolton Seed Medal Lecture. In *Proceedings of the Geo-Congress 2019*. Reston: ASCE.
- Marr, W.L. (2020). *Geotechnical judgment. Risk in geotechnical practice*. ASCE Geo-institute. Geostrata.
- Matos Fernandes, M., Maranha das Neves, E., Salgado, F., Caldeira, L., Pina, R., Flor, A., Brito, J.M., & Tavares, A. (2007). Jet grouting solutions for cut-and-cover subway metro stations in Lisbon downtown. In *Proceedings of the XIV ECSMGE* (Vol. 2, pp. 895-900). Madrid.
- Mineiro, A.J.C. (1971). *Soil mechanics and foundations course*. Instituto Superior Técnico (in Portuguese).
- Norwegian Geotechnical Institute – NGI. (2000). *Ralph B. Peck. Engineer. Educator. A man of judgement* (Publication 207, 75 p.). Norwegian Geotechnical Institute.
- NP ISO 31000. (2012). *Risk management. Main guidelines*. Instituto Português da Qualidade, Caparica, Portugal (in Portuguese).
- Parkin, J. (2000). *Engineering judgment and risk* (224 p.). Thomas Telford.
- Peck, R.B. (1969). *A man of judgment*. The 2nd R.P. Davies Lecture on the practice of engineering. W. VA. Univ. bull. series 70, No. 5-2, Nov. 10 p.
- Peck, R.B. (1980). Where has all the judgment gone? The 5th Laurits Bjerrum Memorial Lecture. *Canadian Geotechnical Journal*, 17(4), 584-590.
- Peck, R.B. (1981). Geotechnical judgment and risk. H. Bolton Seed Medal Lecture. In *Proceedings of the Geo-Congress 2019*. Reston: ASCE.
- Peck, R.B. (1991). *Engineering judgement*. Retrieved in March 1, 2021, from <https://peck.geoengineer.org/resources/videos/singleVideo/41>
- Salgado, F. (2014). Incident at the Terreiro do Paço Lisbon metro in July, 2000. In *Proceedings of the XIV Congresso Nacional de Geotecnia* (28 p.). Coimbra. (in Portuguese).
- Simon, H.A. (1981). *The sciences of the artificial* (3rd ed., 231 p.). MIT Press.
- Vick, S.G. (2002). *Degrees of belief: subjective probability and engineering judgment* (455 p.). ASCE.

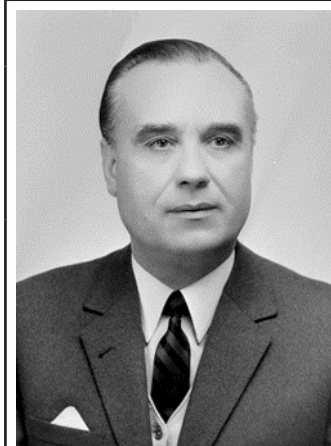

Manuel Rocha (1913-1981) was honoured by the Portuguese Geotechnical Society with the establishment of the Lecture Series bearing his name in 1984.

Having completed the Civil Engineering Degree at the Technical University of Lisbon (1938) he did post-graduate training at MIT. He was the driving force behind the creation of the research team in Civil Engineering that would lead to the foundation of the National Laboratory for Civil Engineering (LNEC), in Lisbon. He was Head of LNEC from 1954 to 1974 and led it to the cutting edge of research in Civil Engineering.

His research work had great impact in the area of concrete dams and rock mechanics. He was the 1st President of the International Society for Rock Mechanics and organized its 1st Congress in Lisbon (1966). He did consultancy work in numerous countries. He was Honorary President of the Portuguese Geotechnical Society, having promoted with great commitment the cooperation between Portugal and Brazil in the area of Civil Engineering, and member of the National Academy of Sciences of the USA. Recognized as a brilliant researcher, scientist and professor, with a sharp, discerning intellect allied to a prodigious capacity for work and management, he was truly a man of many talents.



The 2020 Manuel Rocha Lecture was presented by **José Mateus de Brito**, 71 years old, Geotechnical Consultant, former Head of Geotechnical Department, Partner and Member of the Board Directors of TPF and Cenor Engineering Consulting Companies in Lisbon, Portugal. He got his degree in Civil Engineering in 1972 at Instituto Superior Técnico. He was Assistant Professor of Soil Mechanics, Foundation Design and Seismic Engineering at Instituto Superior Técnico, between 1972 and 1989. He is Geotechnical Expert and Counsellor Member of the Portuguese Engineers Association. He has been involved in consulting and design, including large dams, reservoirs and tailing dams, canals, highways, metros, railways and tunnel systems, bridge and building foundations, cut and cover urban excavations, pile support systems, foundations and soil improvement. He has also experience in supervision, control and management of hydraulic schemes and metro and rail systems. He was Project Manager of recent relevant projects like Sivas Sarkisla Bozkurt Dam, Turkey; Algiers Metro Line 1 – Emir Abdelkader Square-Martyrs Square, Algeria; Foundation Treatment of Road Accesses to Northern Lisbon Logistics Platform, Portugal; Cerro da Mina Reservoir at Somincor Mine, Portugal; Lisbon Metro Terreiro do Paço Underground Station, Portugal. José Mateus de Brito is author and co-author of more than one hundred communications at national and international congresses and delivered several lectures. He has integrated several committees, namely the Dam Safety Commission in Portugal. He was awarded with the Tectonika Engineering Prize 2018 for the work of recognized value developed in geotechnical engineering at the International Construction and Public Works Fair, Lisbon.