

Displacement of piles from pressuremeter test results – a summary of French research and practice

(5th Victor de Mello Goa Lecture)

Roger Frank^{1#} 

Lecture

Keywords

Pile
Displacement
Settlement
Lateral behaviour
Ménard pre-borehole pressuremeter
Self-boring pressuremeter
Barrette.

Abstract

This paper presents the ‘load-transfer functions’ t - z and p - y methods for determining the axial and lateral displacements of single piles. They are based on the results of pressuremeter tests. The methods from the results of the Ménard pre-borehole pressuremeter tests (MPM) and the self-boring pressuremeter tests (PAF, for *Pressiomètre AutoForeur* in French) are described. Especially, the t - z and p - y methods derived from the MPM test results are commonly used in the French practice. For both t - z and p - y curves, some theoretical background (usually FEM calculations in linear elasticity) is given. The results of the t - z and p - y analyses are compared to the measurements from loading tests on full scale piles. A proposal concerning *barrettes* is also presented.

1. Introduction

It is widely accepted that pile foundations should be designed not only with regard to their bearing capacity, but also with regard to their vertical and horizontal displacements. This comes, in particular, from the need to check the deformation of the structures which they carry, under serviceability conditions, as recommended in most of the recent codes, such as Eurocode 7 (CEN, 2004). In other words, the traditional way of mastering pile movements by applying relatively large factors of safety to the bearing capacity does not appear to be anymore the ‘good’ solution. Piles movements are to be assessed directly.

This paper describes how the approaches using the ‘load-transfer functions’ t - z and p - y were developed in France for determining, respectively, axial (vertical) and lateral (horizontal) displacements of single piles from the results of pressuremeter tests. The behaviour of *barrettes* is also mentioned.

The results of two different types of pressuremeter tests are used: the results of pre-borehole Ménard pressuremeter tests (MPM) and the results of self-boring pressuremeter tests (PAF, for ‘Pressiomètre AutoForeur’ in French). The advantage of pressuremeter tests is that they allow to measure in situ deformation properties of the ground (as the expansion curve represents a full shear curve measured in situ). Furthermore, because of the pre-borehole, the MPM can be performed in all kinds of ground from soft soils to very stiff or very dense soils and soft rocks. The advantage

of the PAF is that it measures in situ nearly ‘intact’ elastic shear moduli G of the ground. In the case of the MPM, the (Ménard) pressuremeter moduli E_M are used in an empirical manner. This is due to the pre-borehole which does not allow to control and/or ‘measure’ accurately the disturbance of the ground. In the case of the PAF, the moduli G (or the whole expansion curve), can be used in ‘theoretical’ solutions obtained for an elastic continuum.

Figure 1 compares typical expansion curves. It clearly shows that the PAF curve is stiffer than the MPM curve. From the PAF expansion curve different shear moduli are defined G_{p0} , G_{p2} , G_{p5} , etc. corresponding to an expansion $\Delta V/V_0$, respectively equal to 0% (tangent initial), 2%, 5%, etc. For the MPM, a single modulus is defined, i.e. G_M between p_{0M} (initial at rest pressure for the MPM) and p_p , the ‘creep pressure’. With the assumption that Poisson’s ratio $\nu = 0.33$, the conventional (Ménard) pressuremeter modulus is obtained from G_M :

$$E_M = 2.66 G_M \quad (1)$$

Table 1 gives some mean values of the ratios G_{p0}/G_{p2} , G_{p2}/G_{p5} , G_{p2}/G_M , G_{p5}/G_M and G_{p0}/G_M for clays and sands.

At working levels, the mean strain in the ground around a pile under axial loads is of the order of $\varepsilon \approx 10^{-3}$, while it is of the order of $\varepsilon \approx 10^{-2}$ in the top layers around a pile under lateral loads. The initial stiffnesses of the t - z and p - y models

[#]Corresponding author. E-mail address: roger.frank@enpc.fr

¹École des Ponts ParisTech, Civil Engineering Department, Laboratoire Navier, Geotechnical team-CERMES, Paris, Marne-la-Vallée, France.

Submitted on July 10, 2022; Final Acceptance on August 5, 2022; Discussion open until Invited Lecture. No discussions.

<https://doi.org/10.28927/SR.2022.006822>



This is an Open Access article distributed under the terms of the Creative Commons Attribution License, which permits unrestricted use, distribution, and reproduction in any medium, provided the original work is properly cited.

established from MPM and PAF test results for single piles are consistent with these orders of magnitude (see, e.g., Hoang et al., 2018, for the t - z model from MPM test results).

Finally, the models for single piles described in this paper, are meant to be inserted into the so-called ‘hybrid’ approach for assessing the displacements of group of piles (O’Neill et al., 1977; Estephan et al., 2003, 2006; Perlo et al., 2005).

2. Axial displacements (settlements)

The determination of the load-settlement curve of a single pile under axial loading is based on the concept of shaft friction mobilisation curves, also known as t - z curves (‘load-transfer functions’ for the axial direction).

2.1 t - z curves from MPM results

The first work on the settlements of piles from MPM results was the work carried out by Gambin (1963). The ‘Fascicule 62-V’ French Code (France, 1993) and more recent French Standard (AFNOR, 2012) suggest, in case a settlement estimate must be made, to use the τ - s curves (unit shaft friction-local displacement curves) and q - s_p curve (mean base pressure-base displacement curve) proposed by Frank & Zhao (1982) and Frank (1984). These curves are shown on Figure 2, with k_τ and k_q (Equations 2 and 3) given as functions of the pressuremeter modulus E_M and the diameter ($2r_0$) of the pile:

for cohesive soils and soft rocks:

$$k_\tau = 2.0 \frac{E_M}{(2r_0)} \text{ and } k_q = 11.0 \frac{E_M}{(2r_0)} \quad (2)$$

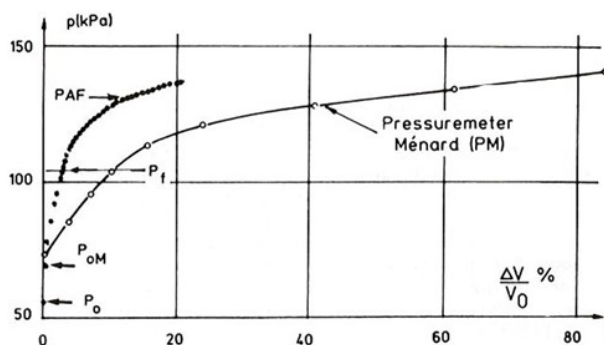

Figure 1. Typical pressuremeter MPM and PAF expansion curves (Baguelin et al., 1978).

for granular soils:

$$k_\tau = 0.8 \frac{E_M}{(2r_0)} \text{ and } k_q = 4.8 \frac{E_M}{(2r_0)} \quad (3)$$

These curves were originally proposed for bored piles in cohesive soils. They were extended to granular soils by using correlations such as those shown in Table 1 and using theoretical results for linear isotropic elastic media (see next section). They are proposed for bored piles and driven piles.

The limit values of unit shaft friction q_s and base pressure q_b are estimated from any well accepted method of calculation of the bearing capacity of piles, e.g., from MPM or PAF tests.

Examples of the use of this MPM method for predicting load-settlement curves of piles are given by Frank (1984), Bustamante et al. (1989) and Bustamante & Frank (1999). More recent developments about the Frank & Zhao curves are given by Abchir et al. (2016) and by Bohn et al. (2017). Figures 3 and 4 show such examples of the use of the Frank

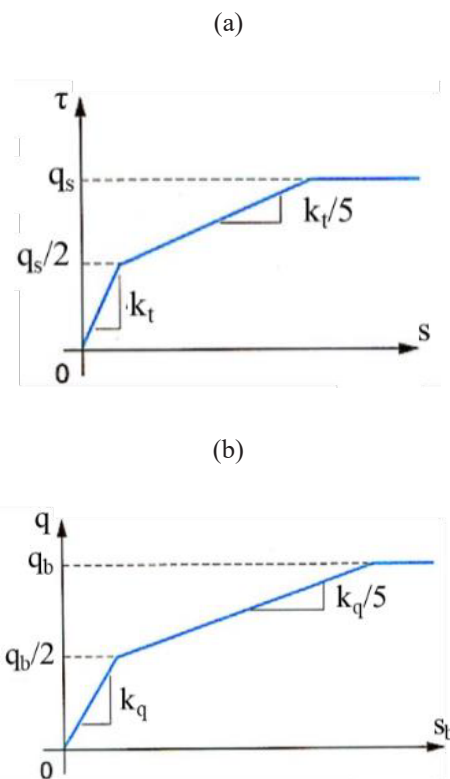

Figure 2. MPM (a) τ - s ($= t$ - z) and (b) q - s_b ($= q$ - z_b) curves (Frank & Zhao, 1982).

Table 1. Correlations between PAF and MPM moduli (Jézéquel & Le Méhauté, 1979).

	G_{p0}/G_{p2}	G_{p2}/G_{p5}	G_{p2}/G_M	G_{p5}/G_M	G_{p0}/G_M
Clays	2.09	1.72	5.42	3.03	11.3
Sands	1.19	1.29	3.47	2.53	4.1

& Zhao (1982) MPM method for the analysis of full-scale static load tests. The Koekelare pile of Figure 3 is a cased screw pile $B = 350\text{mm}/650\text{mm}$ constructed in an Ypresian clay. It can be seen that the prediction of the load-settlement curve is excellent.

Figure 4 shows all the results of the prediction exercise which was organized for the International Symposium ISP5-PRESSIO 2005, taking place at the occasion of the '50 years of pressuremeters' (Reiffsteck, 2006). The pile is a CFA (continuous flight auger bored pile) with a diameter $B = 0.5\text{ m}$ and a length $D = 12\text{ m}$. The pile is embedded

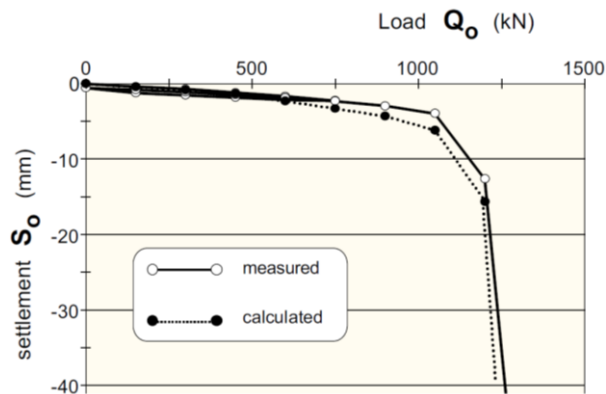

Figure 3. Comparison of measured and calculated load-settlement curves for the Koekelare pile (Bustamante & Frank, 1999).

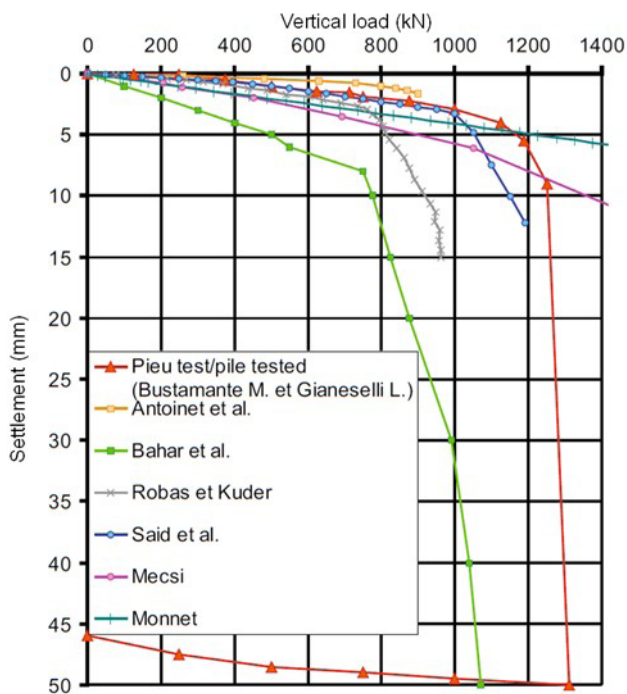

Figure 4. Comparison of the experimental curve with the participants' predictions (Reiffsteck, 2006).

in a 9.6 m thick clay layer, below a 2.4 m thick silt layer. The water-table is located 1.8 m below ground level. It is interesting to note the predictions made by Robas & Kuder (2006) and by Said et al. (2006) are the closest predictions to the whole initial part of the measured load-settlement curve, both used the Frank-Zhao MPM method, and were established completely independently.

2.2 t - z curves from PAF results

2.2.1 Theoretical background

The finite element method (FEM) was used to study the mechanism of shaft friction in isotropic linear elastic media (Frank, 1974). The mechanism was confirmed for linear cross-anisotropic elastic media of vertical axis, also using the FEM (Orsi, 1978). The FEM mesh used for the study is shown on Figure 5. No soil-pile interface elements are inserted. The soil and pile are bound together.

The analyses carried out allowed to establish the predominant mode of deformation near the pile shaft: it is a pure shearing of vertical concentric annuli, as shown on Figure 6.

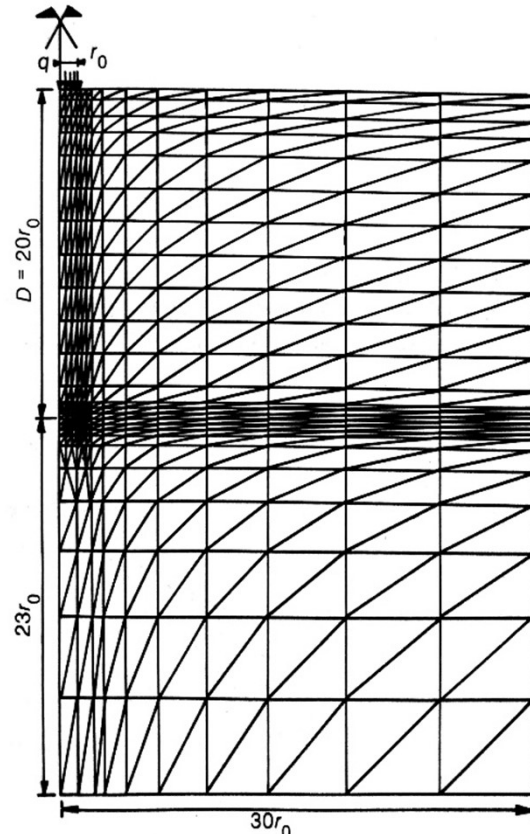

Figure 5. FEM mesh for the study of the mechanism of shaft friction of piles in isotropic linear elastic media (Frank, 1974).

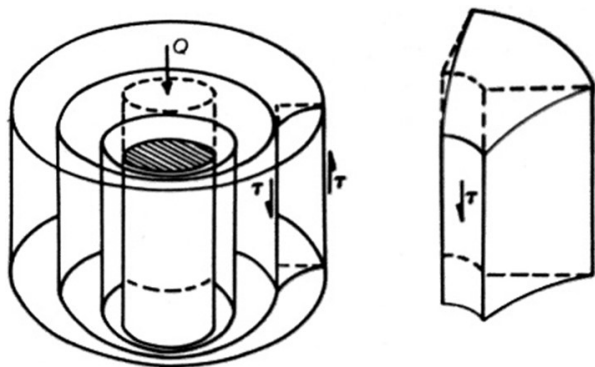

Figure 6. Sketch of the mechanism of pure shearing of vertical concentric annuli (Frank, 1974).

The main outcome of the studies is that the initial stiffness of the t - z curve is related to the elastic shear modulus G_0 of the ground through the relation:

$$t/z = \frac{G_0}{kr_0} \quad (4)$$

where the dimensionless parameter k is a function of the slenderness ratio of the pile $D/2r_0$ (D is the embedded length of the pile and r_0 is the diameter of the pile) and of Poisson's ratio ν of the ground. Figure 7 shows the values of k obtained from Poulos & Davis (1968) and by Randolph (1977) and Orsi (1978). The modulus G_0 can be obtained from undisturbed samples or from the results of PAF tests. In the case of the PAF tests, it is to be noted that the (tangent) initial modulus from the expansion curve G_{p0} usually corresponds to an expansion $\Delta V/V_0$ around 0.2%.

The model was further extended to non-linear media. Figure 8 is a typical example showing the influence of the non-linear terms of the shear curve of the ground (τ, γ) on the friction curve ($t, w_0/r_0$). As seen, the non-linearity of the ground behaviour has a very limited influence on the t - z curve until the mobilization of the limit shaft friction q_s . Thus, a bi-linear curve (initial mobilization followed by a plateau at $t = q_s$) is quite acceptable for all practical purposes. For more details, see e.g. Baguelin & Frank (1980) and Baguelin et al. (1982).

The procedure to establish the bi-linear t - z curve from the results of PAF test is the following:

- make an estimate of the elastic shear modulus G_0 of the ground (e.g. G_{p0} , from the tangent initial stiffness of the PAF expansion curve);
- apply the parameter k (Figure 7) in order to derive the stiffness of the t - z curve: $k_t = G_0/kr_0$;
- make an estimate of the limit shaft friction q_s (as in the case of the MPM method).

With regard to the base of the pile, a simple tri-linear curve q - z_p is also proposed. The initial slope is derived from the Boussinesq settlement of a shallow foundation:

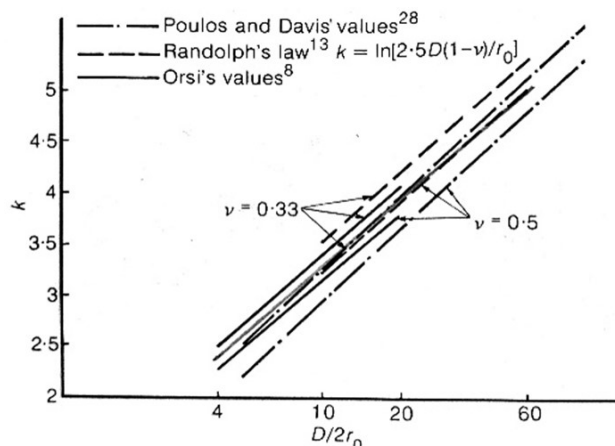

Figure 7. Parameter k as a function of $D/2r_0$ and ν (in isotropic elasticity) (Baguelin & Frank, 1980).

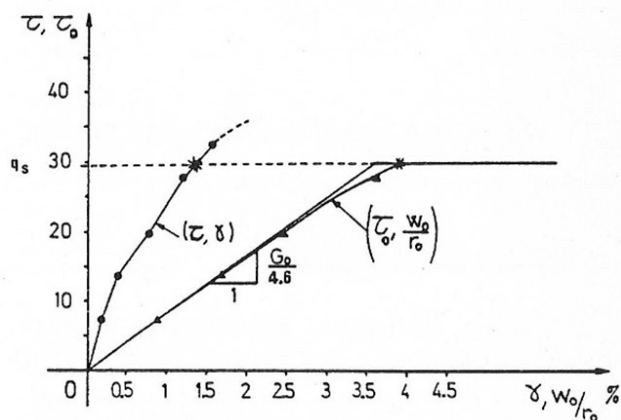

Figure 8. Shear curve (τ, γ) derived from a PAF expansion test and corresponding shaft friction curve ($t, w_0/r_0$) at 3 m depth for the Plancoët pile (Baguelin et al., 1982).

$$k_b = \frac{q}{z_b} = \frac{4G_0}{\pi(1-\nu)r_0I} \quad (5)$$

where I is around 0.85 to 1 (Randolph & Wroth, 1978; Frank, 1984). The mean base pressure q is then limited by the limit base pressure q_b (as in the case of the MPM method).

2.2.2 Examples

The PAF method was applied, in particular, to analyse full scale pull-out tests of two close-ended steel pipe piles driven in marine soils at Cran and Plancoët (Baguelin et al., 1982). Both piles are 27.3 cm in diameter and 6.3 mm thick. The load-displacements curves obtained are compared to the measured (experimental) ones shown on Figures 9 and 10. Results from FEM analyses are also shown. They include interface elements which allow limiting the shear stress to the

limit shaft friction q_s . The Cran pile is 17 m long. The soils at Cran are soft plastic clays underlain by plastic, slightly organic silt. The Plancoët one is 13 m long. The soils at Plancoët are sandy silts, underlain by loose sands and silty clays.

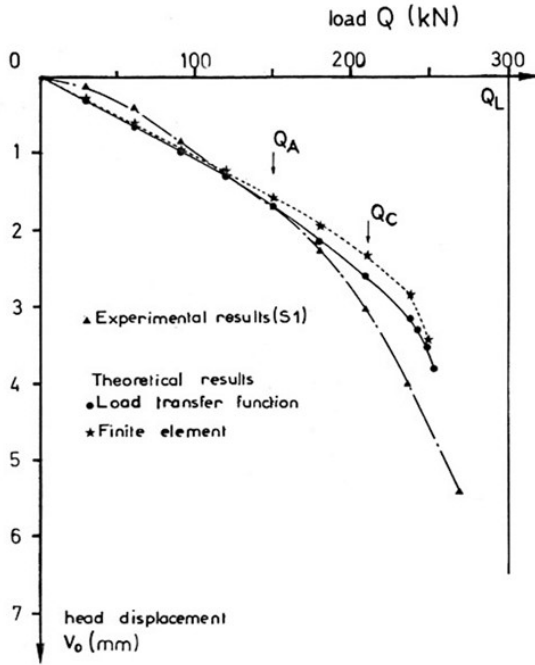

Figure 9. Comparison of measured and calculated load-settlement curves for the pull-out test at Cran.

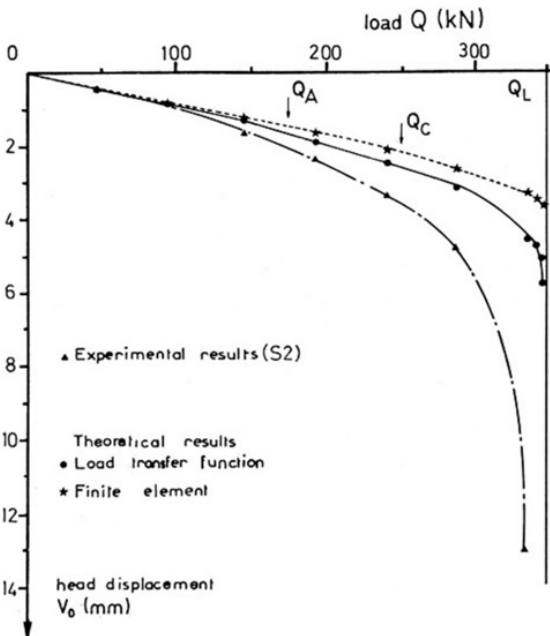

Figure 10. Comparison of measured and calculated load-settlement curves for the pull-out test at Plancoët.

In the case of Cran, the t-z load transfer function analysis matches quite well the experimental results, especially near the working load of the pile (around 150 kN).

In the case of Plancoët, the t-z analysis underestimates the displacement in the vicinity of the working load by a factor of about 0.7 to 0.75, which seems quite acceptable.

3. Lateral displacements

The methods using the subgrade reaction modulus (or p-y reaction curves, p – reaction pressure, y – horizontal displacement) are now well known for the design of piles under lateral loads.

In the following some features of the research carried out by the French Bridges and Highways Laboratories (LPCs) are given. They concerned not only overturning loads at the head, but also lateral thrusts when the soft soil pushes directly on the pile, due to lateral soil movements (at the toe of an embankment, for instance). In this latter case, the pile soil movement y is replaced by the relative displacement $\Delta = y - g$, where g is the displacement of the soil in absence of the pile.

3.1 P-y curves from MPM results

The basic method from MPM results (Ménard, 1962) is also detailed by Baguelin et al (1978). From the results of the test at the considered depth (E_M , Ménard pressuremeter modulus; p_c , creep pressure and p_p , limit pressure), the reaction curve (p, y) of a single pile at a given depth, is established, for long duration loadings, as shown on Figure 11.

The subgrade reaction modulus $k_s = p/y$ of part OA is the one originally proposed by Ménard (1962). When multiplying by the frontal width (or diameter of the foundation) B, the Ménard (horizontal) reaction modulus $E_{sM} = k_s B$ is obtained:

$$E_{sM} = E_M \frac{18\rho}{4(2,65\rho)^\alpha + 3\alpha\rho} \text{ with } \rho = \max\left(\frac{B}{B_0}; 1\right) \quad (6)$$

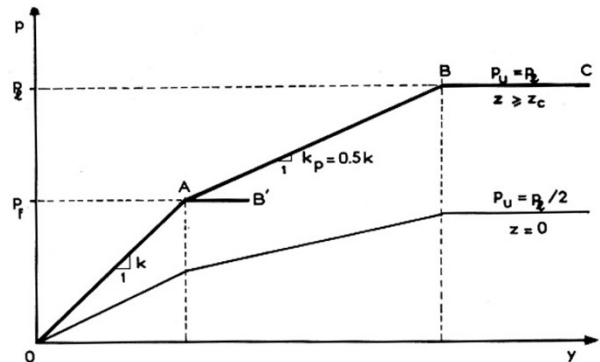

Figure 11. p-y reaction curve from MPM results for long duration loadings (Baguelin et al., 1978).

E_M is the pressuremeter modulus measured at the level under consideration, α is a ‘rheological factor’ depending on the nature of the ground and B_0 is a reference width (or diameter) equal to 0.6 m.

Table 2 gives the values of E_{sM}/E_M for $B \leq 0.6$ m and for $B = 1.2$ m for the various values of α . Note that E_{sM}/E_M ranges between 1.33 and 4 (even 5, or so, for larger piles).

Above the creep pressure p_f ($p_f = p/2$ can be used as an estimate), the non-linear effect is taken into account by reducing the tangent reaction modulus by one half (segment AB on Figure 11). Finally, the ultimate pressure on the pile p_u is taken as being equal to the limit pressure p_l measured with the MPM (segment BC). However, in current practice, the creep pressure should normally not be exceeded, and the displacements and moments should be determined using the law OAB’, which is on the safe side in the case of loads at the head of the pile (it might be the contrary when the pile is submitted to lateral thrusts from the soil – see below).

The p - y curve is, in principle, modified for depth values z lower than a critical depth z_c , due to surface effect. For $z = 0$, the pressures are divided by 2 for the same displacement Δy (or $y - g$) and are then linearly interpolated until $z = z_c$. For cohesive soils z_c is taken equal to $2B$ (B is the diameter of the pile) and for granular soils it is taken equal to $4B$.

The design of piles subjected to lateral soil thrusts, created by nearby slopes for instance, is based on the ‘free soil displacement’ concept. It is assumed that the lateral reaction curve now links the lateral reaction pressure p to the ‘relative’ displacement $\Delta = y - g$, where y is the equilibrium soil-pile lateral displacement sought, and g is the free lateral soil displacement (or displacement in absence of the pile) – see e.g., Bigot et al. (1982) and Frank (1984). The ‘Fascicule 62-V’ French Code (France, 1993) and more recent French standard (AFNOR, 2012) suggest a method for predicting $g(z)$, as a function of depth z , of the characteristics of the slope, of the characteristics of the underlying soft soil and of the location of the pile (see also Frank et al., 2018).

It must be admitted that there are not many cases of comparison of the prediction of the Ménard MPM method with full-scale test results for piles under lateral loadings. However, a certain number of such comparisons are available, in particular some experiments carried out by the LPCs (see Baguelin et al., 1978).

Table 2. Ratio E_{sM}/E_M for estimating the Ménard horizontal reaction modulus E_{sM} from the pressuremeter modulus E_M (Baguelin et al., 1978).

		B < 0.6 m	B = 1.2 m
Peat	$\alpha = 1$	1.33	1.33
Clay	$\alpha = 2/3$	1.9	2.25
Silt	$\alpha = 1/2$	2.3	3
Sand	$\alpha = 1/3$	2.8	4
Sand and Gravel			

As for those with the determination of the reaction curves along the shaft, the experiment on Provins site (which will be briefly reported below) and different research projects at Plancoët on isolated piles, on a group of two piles and on a group of six piles must be mentioned. Also, the measurements taken during 16 years on a steel pipe driven through an unstable slope at Sallèdes (Puy-de-Dôme) are very valuable (Frank & Pouget, 2008). For the group of two piles at Plancoët it is interesting to note that the reaction measured on the trailing pile is found to be reduced by a factor of 0.4 to 0.5 relatively to the leading (front) pile, the distance between the 2 axes being 3 times the frontal width.

From the various experimental evaluations, Baguelin et al. (1978) conclude that the standard MPM method (Figure 11) is, in general, pessimistic for quick monotonic loadings. It tends to overestimate the head displacements and maximum bending moments of piles submitted to loads at their head, and thus is conservative. In reality foundations must often sustain cyclic and/or long duration loads, and the soil can be severely damaged by the installation of the piles, all being parameters very difficult to quantify in everyday practice.

These different facts allow one to think that the method is quite acceptable.

The experiment on the site of Provins in 1974 is interesting because the behaviour of a full scale instrumented pile was examined under head loading, and also when being submitted to lateral thrusts due to the construction of an embankment. The pile is a steel instrumented pipe, of OD = $B = 0.926$ m and thickness $e = 0.015$ m. Furthermore, the 4 stages of the experiment (initial head loading to 120 kN, then embankment construction to a height of 3.8 m, to a height of 6.8 m and after 3 months of consolidation under this final height) were analyzed in detail by using different pressuremeter prediction methods (Bigot et al., 1982).

Figure 12 compares the measured values M of bending moments (left) and displacements (right) (M) for the last level of applied load at the head (120 kN shear load at 0.2 m from ground level) to the results of 3 prediction methods:

- method A, with MPM reaction curves (Figure 11);
- method B uses p - y curves built in the same manner as MPM reaction curves but using appropriate moduli obtained with the PAF. For brevity method B is not discussed in the present paper;
- method C1, with p - y reaction curves constructed on the basis of PAF tests results (see next section).

In the surface layer (silt and clay), the governing one for head loadings, the use of the MPM method of Figure 11 yields a mean soil reaction modulus:

$$E_{sM} = k_s B = 2900 \text{ kPa} (\text{method A}) \quad (7)$$

It is clear from Figure 12 that the MPM method (method A) is on the safe side for short duration head loadings: the maximum bending moment is slightly overestimated and

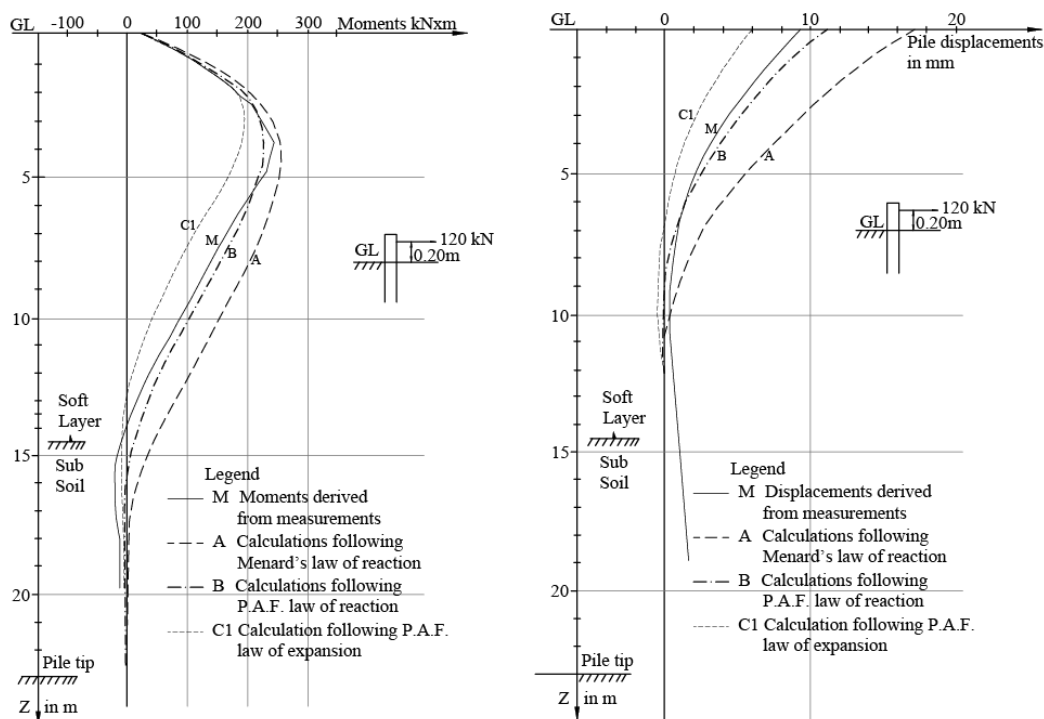

Figure 12. Provins pile: comparison of measured and calculated bending moments and displacements for head loading (Bigot et al., 1982).

the displacements are overestimated by a factor of 2. This is consistent with the conclusions of Baguelin et al. (1978). This also shows that for long duration loadings at the head, the MPM method is quite acceptable, given all the uncertainties.

Figure 13 compares the measured values M of bending moments (left) and displacements (right) (M) after 3 months of consolidation under the final height of the embankment to the results of 3 prediction methods (A, B and C2). Here, the difficulty is the prediction of the bending moments, as it is a 'displacement-imposed' problem. The measured bending moment (curve M) in the upper part is well predicted by the MPM method (curve A). In the lower part the method overestimates the bending moment by a factor of around 1.8, which is largely on the safe side.

The full scale experiment of Sallèdes (steel pipe pile installed through an unstable slope), where the measurements were taken during 16 years, confirmed the great difficulty in predicting accurately the long duration behaviour of piles undergoing lateral thrusts from a moving ground; it is clear that the MPM method overestimates the bending moments of such piles (see Frank & Pouget, 2008, for the extensive analysis of this unique experiment).

3.2 P - y curves from PAF results

3.2.1 Theoretical background

Several theoretical and numerical studies were carried out in order to investigate the behaviour of piles under lateral loads. Bi-dimensional (2D) as well as three-dimensional (3D)

FEM were used, in isotropic linear elasticity. No soil-pile interface elements are used. The pile section (in 2D) or pile (3D) is bound to the soil. Plasticity effects around a pile section were also studied in 2D (Said, 1977; Baguelin et al., 1977). For the 3D analyses, because of the axi-symmetrical geometry of the problem (in the case of circular piles), the method consisting in expressing the loads and displacements in Fourier series is used. Only one single Fourier harmonic is needed here (Carayannacou-Trézos, 1977; Baguelin et al., 1979). For more details, see Baguelin & Frank (1980).

The effects of the shape of the horizontal cross-section of the pile (L/B) were assessed by a 2D study, where L is the length in the horizontal plane and B is the frontal width (the dimension perpendicular to the lateral load). The L/B ratio ranged from 1/5 to 5. Figure 14 shows the mesh used for $L/B = 2$.

For studying the behaviour of *barrettes* under horizontal loads, the soil reaction P is split into its frontal reaction P^{FRONT} (in front and on the back of the pile or "barrette") and its tangential reaction P^{TANG} (on the sides of the pile or "barrette") – see next section, where P is the total soil reaction per unit length of the pile ($P = -dT/dz$, with T the shear load; note that $P = pB$, p being defined as the soil lateral 'reaction pressure').

Figures 15 and 16 show the influence of L/B on P^{FRONT} and P^{TANG} in the case of a homogeneous (intact) linear elastic medium (with E , Young's modulus and ν , Poisson's ratio). The influence of various degrees of remoulding was also studied.

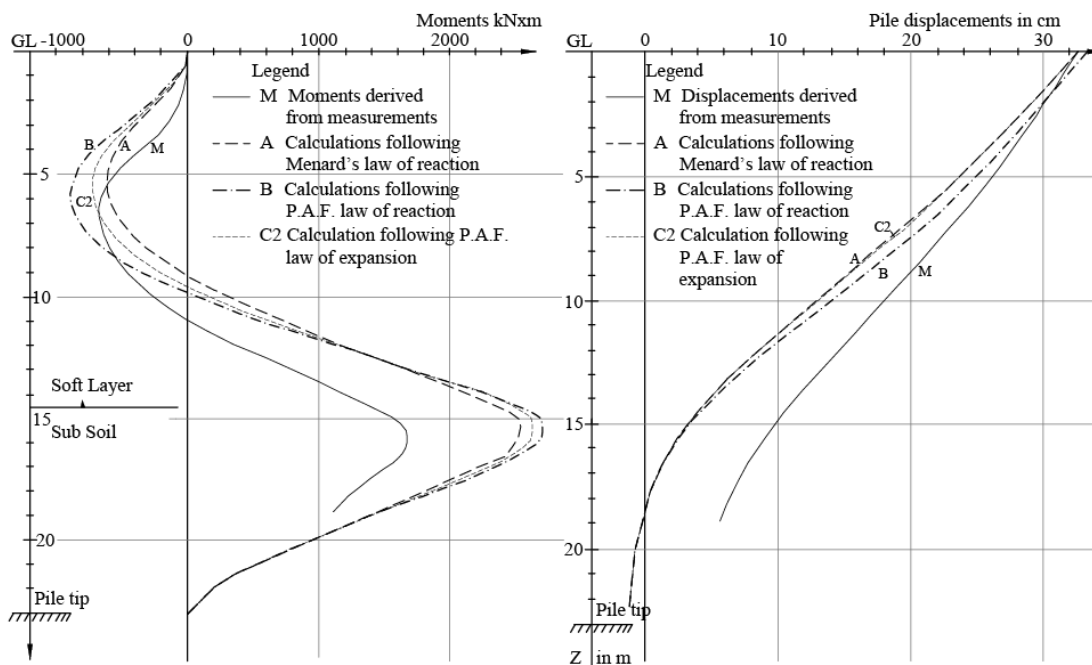

Figure 13. Provins pile: comparison of measured and calculated bending moments and displacements after 3 months of consolidation under final height of embankment (Bigot et al., 1982).

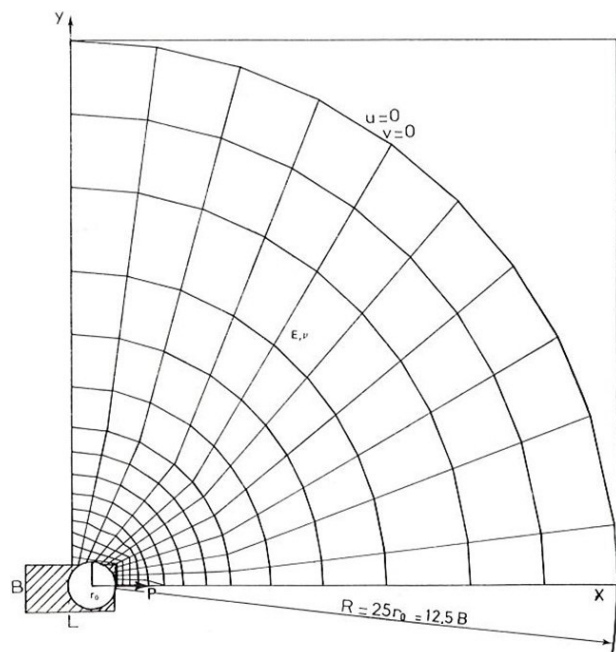

Figure 14. Bi-dimensional FEM mesh in isotropic linear elastic media for a cross-section $L/B = 2$ (Baguelin et al., 1979).

The charts of Figures 15 and 16 allow assessing the corresponding horizontal reaction moduli E_s^{FRONT} and E_s^{TANG} for the frontal and tangential reaction curves, respectively, which are needed for the calculation of the displacements of *barrettes*.

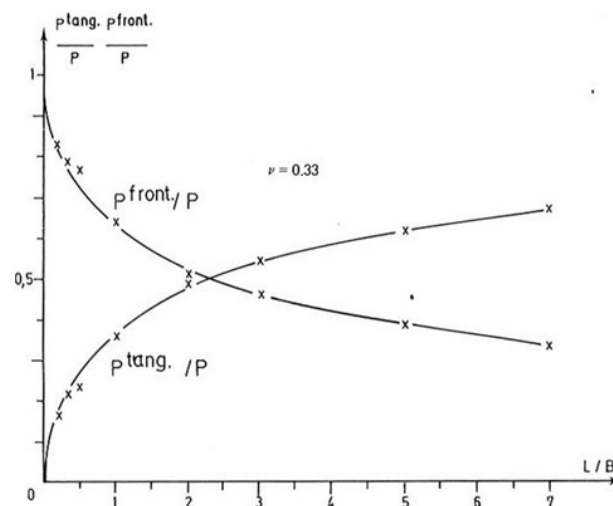

Figure 15. P^{FRONT} and P^{TANG} for $\nu = 0.33$ from 2D finite element calculations.

The effects of the relative pile-soil stiffness, of the slenderness ratio of the pile $D/2r_0$ and of the type of head loading (horizontal force H or bending moment M) are studied in 3D conditions. Two slenderness ratio values are used: $D/2r_0 = 10$ and $D/2r_0 = 25$. The mesh for $D/2r_0 = 10$ is shown on Figure 17.

The soil is represented by a homogeneous (intact) linear elastic medium with Young's modulus E and Poisson's ratio $\nu = 0.33$ (Poisson's ratio has nearly no influence). E_p is the modulus of the pile.

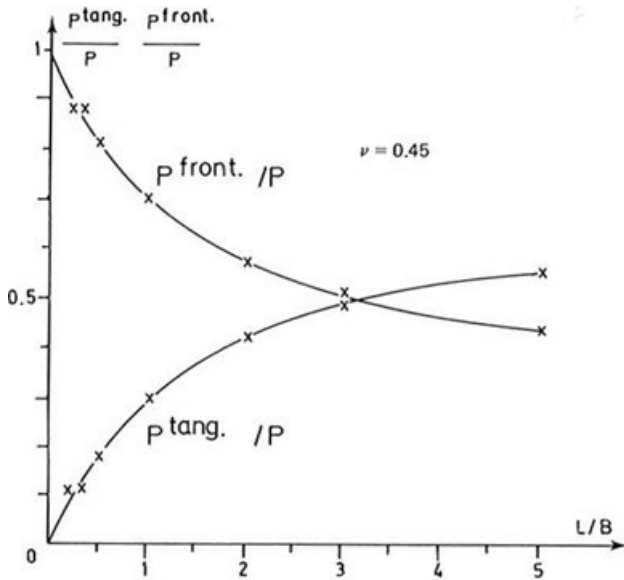

Figure 16: p^{FRONT} and p^{TANG} for $\nu = 0.45$ from 2D finite element calculations.

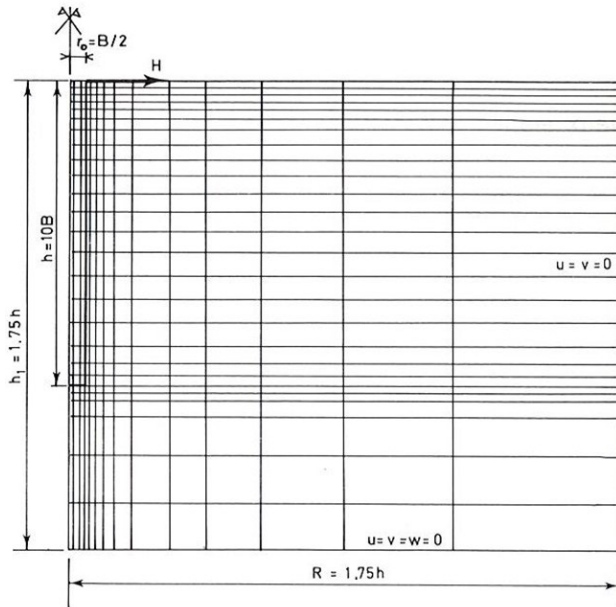

Figure 17. FEM mesh in isotropic linear elastic media for 3D study of laterally loaded piles for piles with $D/2r_0 = 10$.

The study aimed at determining a single ‘equivalent’ reaction modulus $E_{s(u)}$ which would yield the same head horizontal displacement as the FEM calculation. The main findings are reported on Figure 18 for the two slenderness ratios, for the force and moment loadings and for a large range of the relative pile-soil stiffness E_p/E (Frank, 1984).

The main conclusion of this 3D study is that, for all practical purposes, $s = E/E_{s(u)} \sim 0.6-0.7$. Thus the following approximate relation is obtained for the (horizontal) reaction modulus:

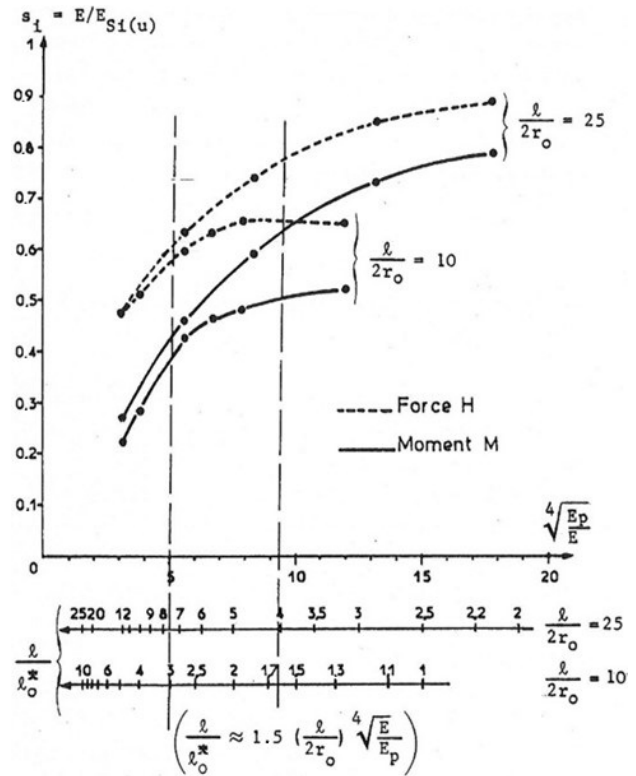

Figure 18. Equivalent horizontal reaction modulus in an intact soil $E_{s(u)}$ as a function of the slenderness ratio $l/2r_0 (= D/2r_0)$, of the relative pile-soil stiffness E_p/E and of the head loading (H or M).

$$E_s = 4G \tag{8}$$

where G is the shear modulus of the elastic soil.

The way of applying PAF test results is then shown on Figure 19 (Amar et al., 1981 a, b). For quick monotonic lateral loading the $p-y$ corresponds to the PAF expansion curve itself. The reaction pressure p on the pile is the net pressure $p^* = p - p_0$ of the PAF test and the relative horizontal displacement y/r_0 of the pile is then the radial strain $\Delta r/r_0$, which is approximately half the expansion $\Delta V/V_0$ of the PAF probe [$\Delta r/r_0 \sim (\Delta V/V_0)/2$]. The ultimate pressure on the pile p_u is equal to the net pressure p^*_{20} at 20% of expansion of the PAF probe. For repeated or permanent (long duration) lateral loadings, such as lateral thrusts on piles, the displacement y (or $y - g$) is multiplied by 2 for the same reaction pressure p . Furthermore, p is respectively limited to $pu = 0.75p^*_{20}$ for sandy soils and to $p_u = 0.5p^*_{20}$ for clayey or silty soils.

Given the fact that the slope of the curve [p^* , $(\Delta V/V_0)/2$] is $2G_0$ for an isotropic linear elastic medium (Lamé’s solution for the thick cylinder), the use of the PAF expansion curve itself as a $p-y/r_0$ comes to assume that the (horizontal) modulus of reaction is

$$E_s = \frac{pB}{y} = \frac{p2r_0}{y} = 4G_p \tag{9}$$

(G_p is G_{p0} , G_{p2} or G_{p5} from the PAF expansion curve).

It thus can be said that the use of the PAF expansion curve as the p - y/r_0 curve for quick monotonic loadings matches the theoretical findings for an isotropic linear elastic medium (given in Figure 18).

In the case of repeated or permanent loading:

$$E_s = 2G_p \tag{10}$$

Furthermore, the non-linearity of the reaction curve (until p_u is reached) is assumed to be same as for the pressuremeter expansion curve.

Table 2 indicates that E_{sM}/E_M ranges between 1.33 and 4, or, in other words, that E_{sM}/G_M ranges between 3.5 and 10.6 which is consistent with the fact that $G_M < G_p$. (Table 1).

3.2.2 Examples

The PAF method indicated on Figure 19 was applied to the Provins pile (Figures 12 and 13).

Figure 12 compares the measured values M of bending moments (left) and displacements (right) for the last level of applied load at the head (120 kN horizontal load at 0.20 m

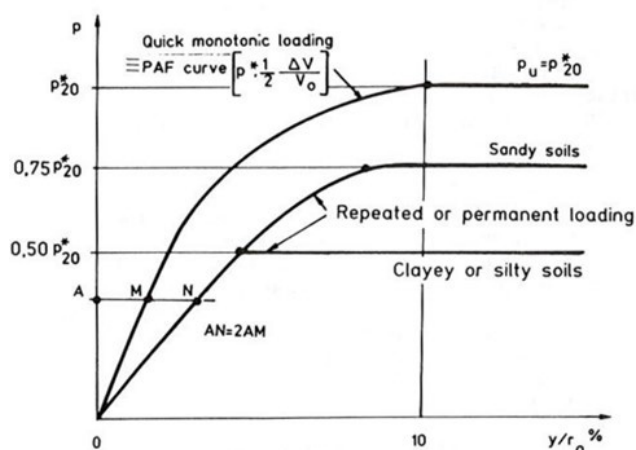

Figure 19. p - y curves derived from PAF expansion curves (Amar et al., 1981a, b).

from ground level) to the calculations with the p - y reaction curves for quick monotonic loadings constructed on the basis of PAF tests results, as shown on Figure 19 (method C1).

In the surface layer (silt and clay), the governing one for head loadings, the use of the PAF expansion curve yields:

$$E_s = 4G_{p2} = 11700 \text{ kPa (method C1)} \tag{11}$$

which is 4 times larger than the Ménard reaction modulus E_{sM} . Indeed, this leads to underestimating both the displacements along the pile, as well as the maximum bending moment.

Figure 13 compares the measured values M of bending moments (left) and displacements (right) after 3 months of consolidation under the final height of the embankment to the calculations with p - y reaction curves for permanent (long duration) loadings constructed on the basis of PAF tests results, as shown on Figure 19 (method C2). For this stage of the experiment, the prediction using the PAF expansion curve with the factor 2 on the y axis is quite satisfactory.

In the case of the experiment of Sallèdes (steel pipe pile installed through an unstable slope), where the measurements were taken during 16 years, the PAF method also overestimates largely the bending moments, as reported above for the MPM method (Frank & Pouget, 2008). It confirms the great difficulty in predicting accurately the long duration behaviour of piles undergoing lateral thrusts from a moving ground.

4. Behaviour of *barrettes*

Barrettes are bored deep foundations of large dimensions in the horizontal plane. They are cast in place with the help of slurry. Usually: $L/B > 2$, where B is the frontal width, perpendicular to the lateral loading (Figure 20).

For axial displacements, the MPM t - z and q - z_p curves of Figure 2 can be used, as well as the PAF method described in section 1.

As these methods are meant for circular piles, some geometrical conversion should be made. The ‘equivalent’ diameter $B = 2r_0$ can be obtained from:

$$A = \frac{\pi B^2}{4} \tag{12}$$

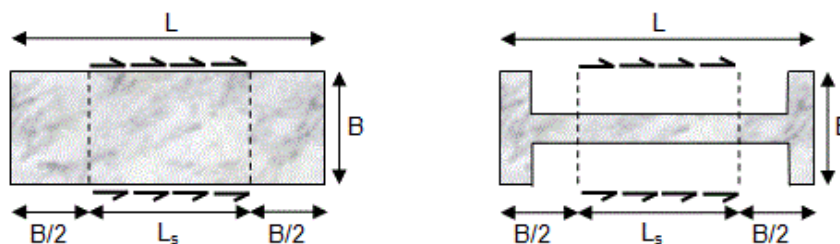

Figure 20. Design lengths for the reaction curves of *barrettes* (France, 1993; AFNOR, 2012).

where A is the area of the ‘full’ horizontal cross-section of the “barrette” $A = BL$.

The limit values of the unit shaft friction q_s and of the base pressure q_u , can be determined from the bearing capacity rules for bored piles with slurry, together with the real area of the shaft and base, respectively. Nevertheless, in the case of *barrettes*, special attention should be paid to the estimate of the equivalent limit pressure p_l^* at the base and equivalent embedment depth for the determination of q_u , as their slenderness ratio B/D may lead to consider them as semi-deep foundations.

The method for assessing behaviour of *barrettes* under lateral loadings is described on Figure 21 (Baguelin et al., 1979).

The principle of the method is to split the total reaction force P (soil reaction per unit length of the pile, in kN/m or MN/m) at a given level into a frontal reaction $P^{FRONT.}$ (on the front and on the back) and a tangential reaction $P^{TANG.}$ (on the sides) for the same horizontal displacement U :

$$P(U) = P^{front.}(U) + P^{tang.}(U) \quad (13)$$

On Figure 21, the lateral reaction forces P , $P^{FRONT.}$ and $P^{TANG.}$ are drawn as functions of the horizontal displacement U . The slopes E_s are thus reaction moduli (in kPa or MPa).

The two reactions $P^{FRONT.}$ and $P^{TANG.}$ correspond, respectively, to the soil reaction (Figure 20):

- on the front and the back and taking into account $B/2$ on each side of the “barrette”;
- on the sides, taking into account $L_s = L - B$ on each side of the “barrette”.

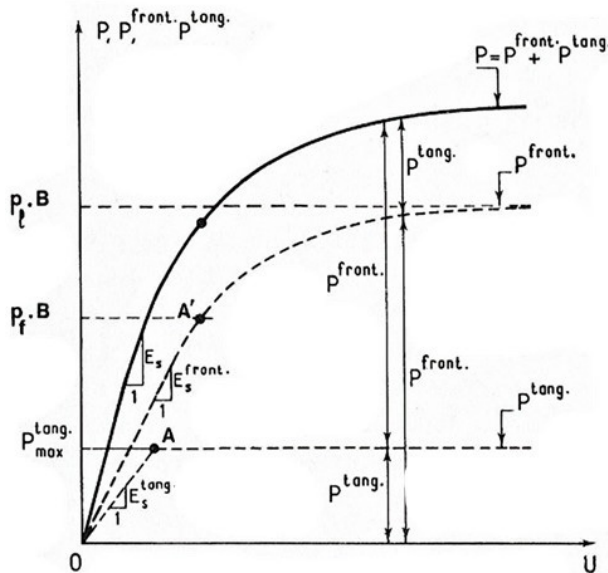

Figure 21. Lateral reaction curves for the design of *barrettes*.

The determination of the reaction curves is the following:

- for $P^{FRONT.}(U)$, the same curve is used as for a pile of diameter B (see previous section);
- for $P^{TANG.}(U)$, the initial slope $E_s^{TANG.}$ up to $P = P_{max}^{TANG.}$ is assessed from the results of the 2D FEM analyses described in the previous section (Figures 15 and 16). These results allow to determine the ratio $E_s^{TANG.}/E_s^{FRONT.}$. The ultimate reaction $P_{max}^{TANG.}$ is equal to:

$$P_{max.}^{tang.} = 2q_{sh}L_s \quad (14)$$

where the horizontal unit shaft friction q_{sh} can be taken as equal to the (axial) limit shaft friction q_s for bored piles with slurry.

5. Conclusion

This paper presented the main results concerning the determination of displacements of single piles from pressuremeter test results. The methods for constructing the ‘load-transfer functions’ $t-z$ and $p-y$ are described. The great advantage of pressuremeter tests is that they provide for deformation parameters measured in situ.

In the case of the Ménard pressuremeter tests (MPM), the pressuremeter modulus E_M is used for deriving such load transfer curves which, in turn, allow to assess the axial (vertical) and lateral displacements of the piles. The transfer curves are mainly empirical. Both the $t-z$ and $p-y$ models derived from the MPM parameters (E_M and p_l) are commonly used in practical design in France.

These types of models, obtained for “simple” problems, are also used for calibrating and validating the choice of moduli of deformation when it comes to solving more complicated problems by numerical methods, such as the finite element method (see, e.g., Bourgeois et al., 2018).

The corresponding curves from the self-boring pressuremeter (PAF) are mainly based on theoretical studies carried out for elastic media. These studies assume that ‘intact’ shear moduli are used. They are taken from the PAF expansion curves.

In all cases, the limit values of shaft friction and end-bearing (for $t-z$ and $q-z_p$ curves) can easily be obtained from any well accepted method for assessing the (vertical) bearing capacity of piles. The (horizontal) ultimate pressures (for $p-y$ curves) are derived from limit pressures measured with the pressuremeter.

The proposed $t-z$ and $p-y$ curves are meant to be inserted into methods for assessing the displacements of group of piles, such as the ‘hybrid’ approach method.

Their validity was exclusively checked on the basis of the results of loading tests on full scale piles. Clearly more well documented full scale test results would help develop them further. But this also means that the influence on the ground of the insertion or of the casting of piles is better known and quantified.

Acknowledgements

It is a great honour for me to be the recipient of the 5th Victor de Mello Goa Lecture. I warmly thank the Goa Chapter of the Indian Geotechnical Society for the nomination.

Dr. Victor de Mello was not only an extraordinary expert in all fields of geotechnical engineering, but also a great example to follow for the younger ones, like me, who had the chance to meet him. It was each time an immense pleasure to have the privilege to discuss with him. He would devote his time and patience to pass on to us his unique vision and love for our profession.

Victor was, of course, always extremely interested in others' work and I must confess that I was very proud when he asked me to send him papers from my research on piles, while he was preparing his book.

For the 5th Victor de Mello Goa Lecture, delivered on the 31st of May 2022, I chose to speak about the prediction of pile displacements from pressuremeter results, which is a subject we often talked about Victor and myself. It happens that I have recently written a synthetic paper about this subject, but never had the chance to present its full content during a lecture*.

Indeed, the paper which follows was originally published as a contribution to the special issue of the Geotechnical Engineering Journal of the SEAGS & AGSSEA, honouring Prof. Harry G Poulos. Its reference is:

FRANK R. (2020). "Displacement of piles from pressuremeter test results – A summary of French research and practice". Geotechnical Engineering Journal of the SEAGS & AGSSEA Vol. 51 No. 2 June 2020 ISSN 0046-5828, 73-82.

I am grateful to the Journal of the SEAGS & AGSSEA and to the Soils and Rocks Journal for the permission to reproduce this synthetic paper.

Paris, 19th April 2022

Roger Frank

*Roger Frank's presentation is available at Victor de Mello's website: <https://victorfbdemello.com.br/>

Declaration of interest

The author has no conflicts of interest to declare.

References

- Abchir, Z., Burlon, S., Frank, R., Habert, J., & Legrand, S. (2016). T-z curves for piles from pressuremeter test results. *Geotechnique*, 66(2), 137-148. <http://dx.doi.org/10.1680/jgeot.15.P.097>.
- AFNOR P 94-262. (2012). *Justification des ouvrages géotechniques. Normes d'application nationale de l'Eurocode 7 - Fondations profondes*. Association Française de Normalization, Paris (in French).
- Amar, S., Baguelin, F., Frank, R., & Jézéquel, J.F. (1981a). L'autoforage. *Travaux*, 552, 63-76. (in French).
- Amar, S., Baguelin, F., Frank, R., & Jézéquel, J.F. (1981b). L'autoforage (Erratum et addendum). *Travaux*, 553, 91. (in French).
- Baguelin, F., & Frank, R. (1980). Theoretical studies of piles using the finite element method. In *Proceedings of the International Conference on Numerical Methods in Offshore Piling* (pp. 83-91), London. Institution of Civil Engineers.
- Baguelin, F., Carayannacou-Trézos, S., & Frank, R. (1979). *Réaction latérale des pieux: effets de forme et effets tridimensionnels* (Bulletin de Liaison des Laboratoires des Ponts et Chaussées, No. 104). Paris: Laboratoire Central des Ponts et Chaussées (in French).
- Baguelin, F., Frank, R., & Jézéquel, J.-F. (1982). Parameters for friction piles in marine soils. In *Proceedings of the 2nd International Conference of Numerical Methods in Offshore Piling* (pp. 197-214), Austin. University of Texas at Austin.
- Baguelin, F., Frank, R., & Said, Y.H. (1977). Theoretical study of lateral reaction mechanism of piles. *Geotechnique*, 27(3), 405-434. <http://dx.doi.org/10.1680/geot.1977.27.3.405>.
- Baguelin, F., Jézéquel, J.F., & Shields, D.H. (1978). *The pressuremeter and foundation engineering* (617 p.). Clausthal-Zellerfeld: Trans Tech Publications.
- Bigot, G., Bourges, F., & Frank, R. (1982). Etude expérimentale d'un pieu soumis aux poussées latérales du sol. *Revue Française de Géotechnique*, 18(18), 29-47. (in French). <http://dx.doi.org/10.1051/geotech/1982018029>.
- Bohn, C., Lopes dos Santos, A., & Frank, R. (2017). Development of axial pile load transfer curves based on instrumented load tests. *Journal of Geotechnical and Geoenvironmental Engineering*, 143(1), 04016081. [http://dx.doi.org/10.1061/\(ASCE\)GT.1943-5606.0001579](http://dx.doi.org/10.1061/(ASCE)GT.1943-5606.0001579).
- Bourgeois E., Burlon S. & Cuira F. (2018). Modélisation numérique des ouvrages géotechniques. *Techniques de l'Ingénieur*, 258, 1-33. <https://doi.org/10.51257/a-v1-c258>.
- Bustamante, M., & Frank, R. (1999). *Current French design practice for axially loaded piles* (Ground Engineering, pp. 38-44). London: Transport Research Laboratory.
- Bustamante, M., Frank, R., & Gianceselli, L. (1989). Prédiction de la courbe de chargement des fondations profondes isolées. In *Proceedings of the 12th International Conference on Soil Mechanics and Foundation Engineering* (Vol. 2, pp. 1125-1126), Rio de Janeiro. Taylor & Francis (in French).
- Carayannacou-Trézos, S. (1977). *Comportement des pieux sollicités horizontalement* [Doctoral thesis]. Université Pierre et Marie Curie (Paris VI) (in French).
- Estéphan, R., Frank, R., Degny, E., & Perlo, S. (2006). *GOUPEG: application de la méthode « hybride » pour le calcul du comportement des groupes et des réseaux élémentaires de micropieux* (Bulletin de Liaison des Laboratoires des Ponts et Chaussées, No. 260). Paris: Laboratoire Central des Ponts et Chaussées (in French).

- Estephan, R., Frank, R., & Degny, E. (2003). Effet d'inclinaison des micropieux dans un groupe: Approche par une méthode hybride. In *Proceedings of the European Conference on Soil Mechanics and Geotechnical Engineering* (pp. 541-546), Prague.
- European Committee for Standardization – CEN. (2004). *Eurocode 7: geotechnical design - part 1: general rules, EN 1997-1:2004 (E), (F) and (G)*. Brussels.
- France. Ministère de l'Équipement, du logement et des transports – MELT. (1993). Règles Techniques de Conception et de Calcul des Fondations des Ouvrages de Génie Civil. Cahier des clauses techniques générales applicables aux marchés publics de travaux. *Journaux Officiels* (Fascicule No. 62, Titre V, Textes Officiels N° 93-3 T.O). (in French).
- Frank, R. (1974). *Etude théorique du comportement des pieux sous charge verticale: introduction de la dilatance* [Doctoral thesis] Université P. et M. Curie (Paris VI) (in French).
- Frank, R. (1984). *Contributions à l'étude des fondations profondes et des essais en place par autoforage* [Thèse de Doctorat d'état ès Sciences Physiques]. Université P. et M. Curie (Paris VI) (in French).
- Frank, R., & Pouget, P. (2008). Experimental pile subjected to long duration thrusts owing to a moving slope. *Geotechnique*, 58(8), 645-658. <http://dx.doi.org/10.1680/geot.2008.58.8.645>.
- Frank, R., & Zhao, S.R. (1982). *Estimation par les paramètres pressiométriques de l'enfoncement sous charge axiale de pieux forés dans des sols fins* (Bulletin de Liaison des Laboratoires des Ponts et Chaussées, No. 119). Paris: Laboratoire Central des Ponts et Chaussées. (in French).
- Frank, R., Cuira, F., & Burlon, S. (2018). *Calcul des fondations superficielles et profondes*. Paris: Presses des Ponts. (in French).
- Gambin, M. (1963). Calcul d'une fondation profonde en fonction des résultats pressiométriques. *Sols-soils*, 7, 11-31. (in French).
- Hoang, M.T., Fahd, C., Dias, D., & Miraillet, P. (2018). Estimation du rapport E/EM: application aux radiers de grandes dimensions. *Journées Nationales de Géotechnique et de Géologie de l'Ingénieur*, 2018, 13-15. (in French).
- Jézéquel, J.F., & Le Méhauté, A. (1979). *Rapport de F.A.E.R.* Paris: Laboratoire Régional des Ponts et Chaussées de St Briuc. (in French).
- Ménard, L. (1962). Comportement d'une fondation profonde soumise à des efforts de renversement. *Sols-soils*, 3, 9-27. (in French).
- O'Neill, M.W., Ghazzaly, O.I., & Ha, H.B. (1977). Analysis of three dimensional pile groups with non-linear soil response and pile-soil-pile interaction. In *Proceedings of the 9th Offshore Technology Conference* (pp. 245-256), Houston.
- Orsi, J.P. (1978). *L'autoforage et le frottement latéral des pieux: étude théorique de l'essai à la sonde frottante* [Doctoral thesis]. Ecole Nationale des Ponts et Chaussées (in French).
- Perlo, S., Frank, R., Degny, E., & Estephan, R. (2005). Analyse de groupes de micropieux sous charge transversale par une méthode hybride. In *Proceedings of the 16th International Conference on Soil Mechanics and Geotechnical Engineering* (pp. 2031-2034). Osaka: IOS Press. (in French). Retrieved in July 10, 2022, from <https://ebooks.iospress.nl/publication/43780>
- Poulos, H.G., & Davis, E.H. (1968). The settlement behaviour of single axially loaded incompressible piles and piers. *Geotechnique*, 18(3), 351-371. <http://dx.doi.org/10.1680/geot.1968.18.3.351>.
- Randolph, M.F. (1977). *A theoretical study of the performance of piles* [Doctoral thesis, University of Cambridge]. University of Cambridge's repository. Retrieved in July 10, 2022, from <https://www.repository.cam.ac.uk/handle/1810/250739>
- Randolph, M.F., & Wroth, C.P. (1978). Analysis of deformation of vertically loaded piles. *Journal of the Geotechnical Engineering Division*, 104(12), 1465-1488. <http://dx.doi.org/10.1061/AJGEB6.0000729>.
- Reiffsteck, P. (2006). Portance et tassements d'une fondation profonde - Présentation des résultats du concours de prévision. In *Proceedings of the International Symposium 50 years of Pressuremeters (ISP 5-Pressio 2005)* (pp. 521-535), Marne-la-Vallée. Presses des Ponts (in French).
- Robas, A., & Kuder, S. (2006). Bearing capacity and settlement, prediction of a bored pile. In *Proceedings of the International Symposium 50 years of Pressuremeters (ISP 5-Pressio 2005)* (pp. 609-611), Marne-la-Vallée. Presse des Ponts.
- Said, I., Frank, R., & De Gennaro, V. (2006). Capacité portante et tassements d'un pieu foré à la tarière continue (prévision pour ISP –Pressio 5). In *Proceedings of the International Symposium 50 years of Pressuremeters (ISP 5-Pressio 2005)* (pp. 613-617), Marne-la-Vallée. Presse des Ponts.
- Said, Y.H. (1977). *Etude théorique des pieux sollicités horizontalement* [Doctoral thesis]. Université Pierre et Marie Curie (Paris VI).